

Kyocera's series of Multilayer Ceramic Chip Capacitors are designed to meet a wide variety of needs. We offer a complete range of products for both general and specialized applications, including the general-purpose CM series, the high-voltage CF series, the low profile CT series, and the DN series for automotive uses.

## Features

- We have factories worldwide in order to supply our global customer bases quickly and efficiently and to maintain our reputation as one of the highest-volume producers in the industry.
- All our products are highly reliable due to their monolithic structure of high-purity and superfine uniform ceramics and their integral internal electrodes.
- By combining superior manufacturing technology and materials with high dielectric constants, we produce extremely compact components with exceptional specifications.
- Our stringent quality control in every phase of production from material procurement to shipping ensures consistent manufacturing and super quality.
- Kyocera components are available in a wide choice of dimensions, temperature characteristics, rated voltages, and terminations to meet specific configurational requirements.

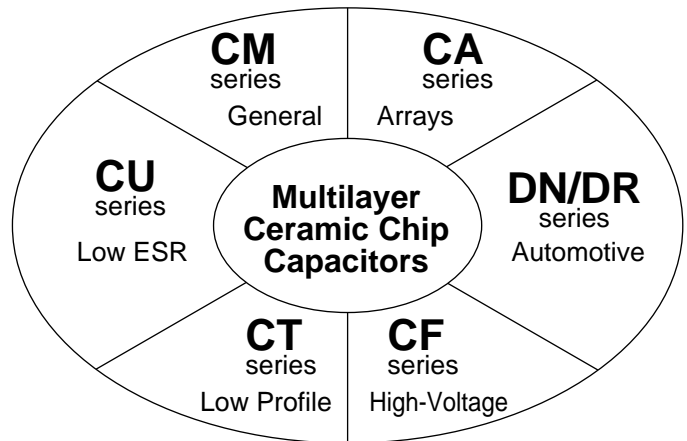
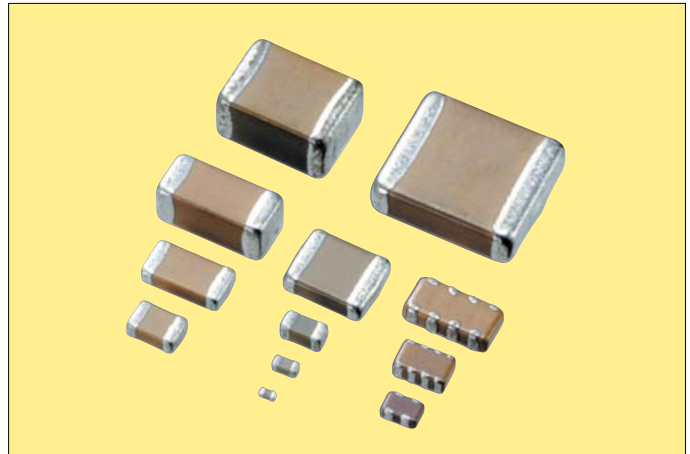

## Structure

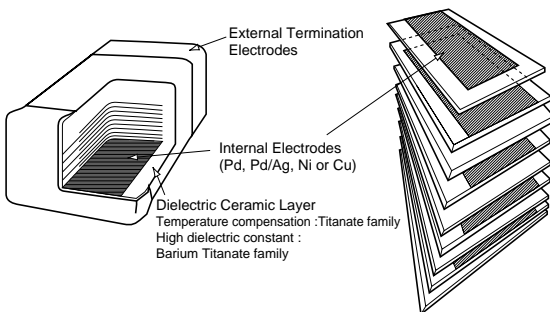

Nickel Barrier Termination Products

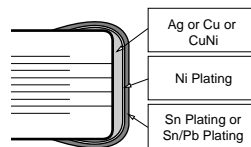

## Tape and Reel



## Bulk Cassette

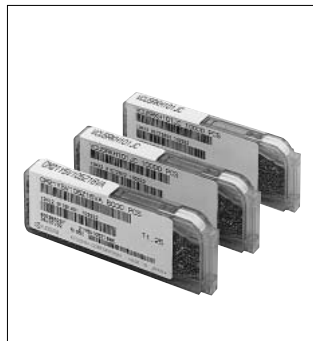

Please contact your local AVX, Kyocera sales office or distributor for specifications not covered in this catalog.

Our products are continually being improved. As a result, the capacitance range of each series is subject to change without notice. Please contact an sales representative to confirm compatibility with your application.

Kyocera Ceramic Chip Capacitors are available for different applications as classified below:

Series	Dielectric Options	Typical Applications	Features	Terminations	Available Size (EIA)
<b>CM</b>	C0G (NP0) X5R X7R X6S X7S Y5V NTC*	General Purpose	Wide Cap Range	Nickel Barrier	0201, 0402, 0603 0805, 1206, 1210 1812, 2211, 2220
<b>CF</b>	C0G (NP0) X7R	High Voltage & Power Circuits	High Voltage 250VDC, 630VDC 1000VDC, 2000VDC 3000VDC, 4000VDC	Nickel Barrier	0805, 1206, 1210 1812, 2208, 1808 2220
<b>CT</b>	C0G (NP0) X5R X7R Y5V	PLCC (Decoupling)	Low Profile	Nickel Barrier	0402, 0603, 0805 1206, 1210
<b>*DN/DR</b>	C0G (NP0) U (750) X7R	Automotive	Thermal shock Resistivity High Reliability	Nickel Barrier	0603, 0805, 1206
<b>CU</b>	C0G (NP0)	RF Circuit	Low ESR	Nickel Barrier	0402, 0603
<b>CA</b>	C0G (NP0) X5R	Digital Signal Pass line	Reduction in Placing Costs	Nickel Barrier	0405, 0508, 0612

\* NTC: Negative Temperature coefficient types are available on request.

\* DN Series: Silver Palladium termination is available on request.

\* CA Series: X7R, Y5V are available on request.

## Dimensions

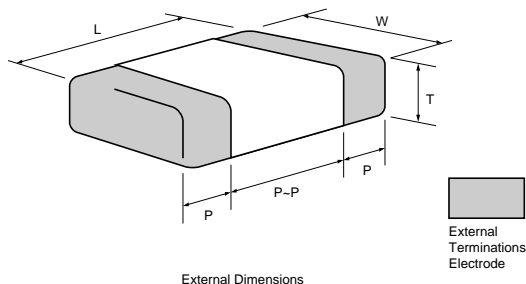

## Tape & Reel

Size	EIA CODE	EIAJ CODE	Dimensions (mm)					
			L	W	P min	P max	P to P min	T max
03	0201	0603	0.6±0.03	0.3±0.03	0.10	0.20	0.20	0.33
05	0402	1005	1.0±0.05	0.5±0.05	0.15	0.35	0.30	0.55
105	0603	1608	1.6±0.10	0.8±0.10	0.20	0.60	0.50	0.90
21	0805	2012	2.0±0.10	1.25±0.10	0.20	0.75	0.70	1.35
316	1206	3216	3.2±0.20	1.60±0.15	0.30	0.85	1.40	1.75
32	1210	3225	3.2±0.20	2.50±0.20	0.30	1.00	1.40	2.70
42	1808	4520	4.5±0.20	2.00±0.20	0.15	0.85	2.60	2.20
43	1812	4532	4.5±0.30	3.20±0.20	0.30	1.10	2.00	3.0
52	2208	5720	5.7±0.40	2.00±0.20	0.15	0.85	4.20	2.20
53	2211	5728	5.7±0.40	2.80±0.20	0.15	0.85	4.20	2.80
55	2220	5750	5.7±0.40	5.00±0.40	0.30	1.40	2.50	2.70

• CT21, CT316 : (L) 3.2±0.2mm and (W) 1.6±0.2mm

• T (Thickness) depends on capacitance value.

Standard thickness is shown on the appropriate product pages.

• DR series 105, 21 size (L)(W)(T) Tolerance ±0.15mm

• CA series (please refer page 19)

## Bulk Cassette

Size	EIA CODE	EIAJ CODE	L	W	T	P		P to P
						min	max	min
05	0402	1005	1.0±0.05	0.5±0.05	0.5±0.05	0.15	0.35	0.30
105	0603	1608	1.6±0.07	0.8±0.07	0.8±0.07	0.20	0.60	0.50
21	0805	2012	2.0±0.1	1.25±0.1	0.6±0.1/1.25±0.1	0.20	0.75	0.70

## KYOCERA PART NUMBER:

**CM 21 X7R 104 K 50 A T**

### SERIES CODE

CM = General Purpose    CA = Capacitor Arrays  
 CF = High Voltage      CU = Low ESR  
 CT = Low Profile  
 DN/DR = Automotive

### SIZE CODE

SIZE	EIA (EIAJ)	SIZE	EIA (EIAJ)	SIZE	EIA (EIAJ)
03	= 0201 (0603)	21	= 0805 (2012)	52	= 2208 (5720)
05	= 0402 (1005)	316	= 1206 (3216)	53	= 5728 (2211)
105	= 0603 (1608)	32	= 1210 (3225)	55	= 2220 (5750)
F12	= 0508 (1220)/4cap	42	= 1808 (4520)	D11	= 0405 (1012)/2cap
F13	= 0612 (1632)/4cap	43	= 1812 (4532)	D12	= 0508 (1220)/2cap

### DIELECTRIC CODE

**CODE EIA CODE**  
 CG = C0G (NPO)            X7S = X7S  
 X5R = X5R                  X6S = X6S (Option)  
 X7R = X7R                  Y5V = Y5V  
 Negative dielectric types are available on request.

### CAPACITANCE CODE

Capacitance expressed in pF. 2 significant digits plus number of zeros.

For Values < 10pF, Letter R denotes decimal point,

eg. 100000pF = 104      1.5pF = 1R5  
 0.1μF = 104            0.5pF = R50  
 4700pF = 472          100μF = 107

### TOLERANCE CODE

A = ±0.05pF    D = ±0.5pF    J = ±5%      Z = -20 to +80%  
 B = ±0.1pF    F = ±1pF      K = ±10%  
 C = ±0.25pF   G = ±2%      M = ±20%

### VOLTAGE CODE

04 = 4VDC	100 = 100VDC	1000 = 1000VDC
06 = 6.3VDC	250 = 250VDC	2000 = 2000VDC
10 = 10VDC	400 = 400VDC	3000 = 3000VDC
16 = 16VDC	630 = 630VDC	4000 = 4000VDC
25 = 25VDC		
35 = 35VDC		
50 = 50VDC		

### TERMINATION CODE

A = Nickel Barrier            C = Silver (\*option)  
 B = Silver Palladium (\*option)

### PACKAGING CODE

B = Bulk	L = 13" Reel Taping & 4mm Cavity pitch
C = Bulk Cassette	H = 7" Reel Taping & 2mm Cavity pitch
T = 7" Reel Taping & 4mm Cavity pitch	N = 13" Reel Taping & 2mm Cavity pitch

### OPTION

Thickness max value is indicated in CT series

EX. 125 → 1.25mm max  
 095 → 0.95mm max

## High Dielectric Constant

EIA Dielectric	Temperature Range	$\Delta C_{max}$
X5R	-55 to 85°C	±15%
X7R	-55 to 125°C	
X7S	-55 to 125°C	±22%
X6S	-55 to 105°C	
Y5V	-30 to 85°C	-82 to +22%

## Temperature Compensation Type

Electric Code Value (pF)	1B/C0G	P $\Delta$ N150	R $\Delta$ N220	S $\Delta$ N330	T $\Delta$ N470	U $\Delta$ N750	SL +350 to -1000
0.5-2.7	CK	PK	RK	SK	TK	UK	SL
3.0-3.9	CJ	PJ	RJ	SJ	TJ	UJ	SL
4.0-9.0	CH	PH	RH	SH	TH	UJ	SL
≥10	CG	PH	RH	SH	TH	UJ	SL

K = ±250ppm/°C, J = ±120ppm/°C, H = ±60ppm/°C, G = ±30ppm/°C  
e.g. CG = 0±30ppm/°C, PH = -150±60ppm/°C

Note: All parts will be marked as "CG" but will conform to the above table.

## Available Tolerances

Dielectric materials, capacitance values and tolerances are available in the following combinations only:

EIA Dielectric	Standard Tolerance	Capacitance
COG NTC *1	*4 A=±0.05pF	≤0.5pF
	*4 B=±0.1pF	≤5pF
	C=±0.25pF	*2 <10pF
	D=±0.50pF	
	F=±1pF	
	G=±2%	≥10pF E12 Series
J=±5%		
K=±10%		
X5R X6R X7R	*3 K=±10%	E6 Series
Y5V	M=±20%	
	Z=-20% to +80%	E3 Series

Note:

\*1 NTC : Negative Temperature Compensation types are available on request as shown on product pages.

\*2 Nominal values below 10pF are available in the standard values of 0.5pF, 1.0pF, 1.5pF, 2.0pF, 3.0pF, 4.0pF, 5.0pF, 6.0pF, 7.0pF, 8.0pF, 9.0pF, 10pF.

\*3 J = ±5% for X7R(X5R) is available on request.

\*4 option

## E Standard Number

E3	E6	E12	E24 (Option)	
1.0	1.0	1.0	1.0	1.1
		1.2	1.2	1.3
	1.5	1.5	1.5	1.6
		1.8	1.8	2.0
2.2	2.2	2.2	2.2	2.4
		2.7	2.7	3.0
	3.3	3.3	3.3	3.6
		3.9	3.9	4.3
		4.7	4.7	5.1
4.7	4.7	4.7	4.7	5.1
		5.6	5.6	6.2
	6.8	6.8	6.8	7.5
		8.2	8.2	9.1

## Features

We offer a diverse product line ranging from ultra-compact (0.6×0.3 mm) to large (5.7×5.0 mm) components configured for a variety of temperature characteristics, rated voltages, and packages. We offer the choice and flexibility for almost any applications.

## Application

This standard type is ideal for use in a wide range of applications, from commercial to industrial equipment.

## Temperature Compensation Dielectrics

Size (mm)	CM03 (0603)						CM05 (1005)						CM105 (1608)		CM21 (2012)				CM316 (3216)			CM32 (3225)
	CΔ			UΔ		SL	CΔ			UΔ	SL	CΔ	CΔ				CΔ			CΔ		
Rated Voltage (VDC)	10	16	25	16	25	25	16	25	50	50	50	50	100	16	25	50	100	25	50	100	50	
Capacitance (pF)																						
R20																						
R50																						
1R0																						
1R5																						
2.0																						
3.0																						
4.0																						
5.0																						
6.0																						
7.0																						
8.0																						
9.0																						
100																						
120																						
15																						
18																						
22																						
27																						
33																						
39																						
47																						
56																						
68																						
82																						
101																						
121																						
150																						
180																						
220																						
270																						
330																						
390																						
470																						
560																						
680																						
820																						
102																						
122																						
1500																						
1800																						
2200																						
2700																						
3300																						
3900																						
4700																						
5600																						
6800																						
8200																						
103																						
123																						
15000																						
18000																						

## Thickness and standard package quantity

Size	03	05	105	*105	21, 316, 32								
Thickness (mm)	<b>A</b>	<b>B</b>	<b>C</b>	<b>C</b>	<b>D</b>	<b>E</b>	<b>F</b>	<b>G</b>	<b>H</b>	<b>I</b>	<b>J</b>	<b>K</b>	<b>L</b>
	0.3±0.03	0.5±0.05	0.8±0.1	0.8±0.1	0.6±0.1	0.85±0.1	1.15±0.1	1.25±0.1	1.4max	1.6max	1.6±0.15	2.0±0.2	2.5±0.2
Taping(180 dia reel)	15kp(P8)	10kp(P8)	4kp(P8)	8kp(P8)	4kp(P8)	4kp(P8)	3kp(E8)	3kp(E8)	3kp(E8)	2.5kp(E8)	2.5kp(E8)	2kp(E8)	1kp(E8)
Taping(330 dia reel)	—	50kp(P8)	10kp(P8)	20kp(P8)	10kp(P8)	10kp(P8)	10kp(E8)	10kp(E8)	10kp(E8)	5kp(E8)	5kp(E8)	5kp(E8)	—

Note : P8 = 8mm width paper tape  
E8 = 8mm width plastic tape  
E12 = 12mm width plastic tape

\* Carrier tape 2mm pitch from one capacitor to another.

Size	43, 55			
Thickness (mm)	<b>J</b>	<b>K</b>	<b>L</b>	<b>M</b>
	1.6±0.15	2.0±0.2	2.5±0.2	2.8±0.2
Taping(178 dia reel)	1kp(E12)	1kp(E12)	0.5kp(E12)	0.5kp(E12)
Taping(330 dia reel)	—	—	—	—

X5R Dielectric

Size (mm)	CM03 (0603)			CM05 (1005)					CM105 (1608)						CM21 (2012)							
	10	16	25	4	6.3	10	16	25	50	4	6.3	10	16	25	35	50	6.3	10	16	25	35	50
Rated Voltage (VDC)																						
Capacitance (pF)																						
101 100																						
151 150																						
220																						
330																						
470																						
680																						
102 1000																						
152 1500																						
2200																						
3300																						
4700																						
6800																						
103 10000																						
153 15000																						
22000																						
33000																						
47000																						
68000																						
104 100000																						
154 150000																						
220000																						
330000																						
470000																						
680000																						
105 1000000																						
155 1500000																						
2200000																						
3300000																						
4700000																						
6800000																						
106 10000000																						

Size (mm)	CM316 (3216)						CM32 (3225)						CM43 (4532)				
	6.3	10	16	25	35	50	6.3	10	16	25	35	50	6.3	10	25	50	
Rated Voltage (VDC)																	
Capacitance (pF)																	
104 100000																	
220000																	
470000																	
105 1000000																	
2200000																	
4700000																	
106 10000000																	
22000000																	
47000000																	
107 100000000																	

\* Non standard specification, please contact us for further information.

▨ Optional Spec.

\*1 Length(L, T) tolerance ±0.15

\*2 Length(L, T) tolerance ±0.2

## X7R, X7S Dielectric

Size (mm)	CM03 (0201)	CM05 (0402)				CM105 (0603)						CM21 (0805)							
Rated Voltage (VDC) Capacitance (pF)	16	6.3	16	25	50	6.3	10	16	25	50	100	4	10	16	25	50	100		
101 100	A																		
151 150																			
220																			
330																			
102 470					B														
680																			
1000																			
152 1500											C	C							
2200																			
3300																			
4700																			
103 6800			B	B													D E		
10000																			
153 15000																			
22000																			
104 47000		B															D E F G		
68000																			
100000																			
154 150000																			
220000																			
330000																			
105 470000																			
680000																			
155 1000000																			
2200000																			
3300000																			
4700000																			

Size (mm)	CM316 (1206)						CM32 (1210)						CM43 (1812)			CM55 (2220)	
Rated Voltage (VDC) Capacitance (pF)	6.3	10	16	25	50	100	6.3	10	16	25	50	100	16	50	100	100	
103 10000																	
22000																	
104 47000																	
100000																	
105 220000																	
470000																	
1000000																	
2200000																	
4700000																	
106 10000000																	
22000000																	

\* Only X7S available  
\*2 Length(W, T) Tolerance ±0.2, X7S available

## Y5V Dielectric

Size (mm)	CM03 (0201)	CM05 (0402)			CM105 (0603)				CM21 (0805)				CM316 (1206)				CM32 (1210)					
Rated Voltage (VDC) Capacitance (pF)	6.3	10	16	25	50	10	16	25	50	10	16	25	50	10	16	25	50	10	16	25	50	
102 1000		A																				
2200																						
4700																						
103 10000	A																					
22000																						
47000																						
104 100000																						
220000																						
470000																						
105 1000000																						
2200000																						
4700000																						
106 10000000																						
22000000																						
47000000																						

## Thickness and standard package quantity

Size	03	05	105	*105	21, 316, 32									
Thickness (mm)	A	B	C	C	D	E	F	G	H	I	J	K	L	
	0.3±0.03	0.5±0.05	0.8±0.1	0.8±0.1	0.6±0.1	0.85±0.1	1.15±0.1	1.25±0.1	1.4max	1.6max	1.6±0.15	2.0±0.2	2.5±0.2	
Taping(180 dia reel)	15kp(P8)	10kp(P8)	4kp(P8)	8kp(P8)	4kp(P8)	4kp(P8)	3kp(E8)	3kp(E8)	3kp(E8)	2.5kp(E8)	2.5kp(E8)	2kp(E8)	1kp(E8)	
Taping(330 dia reel)	—	50kp(P8)	10kp(P8)	20kp(P8)	10kp(P8)	10kp(P8)	10kp(E8)	10kp(E8)	10kp(E8)	5kp(E8)	5kp(E8)	5kp(E8)	—	

Size	43, 55			
Thickness (mm)	J	K	L	M
	1.6±0.15	2.0±0.2	2.5±0.2	2.8±0.2
Taping(178 dia reel)	1kp(E12)	1kp(E12)	0.5kp(E12)	0.5kp(E12)
Taping(330 dia reel)	—	—	—	—

Note : P8 = 8mm width paper tape  
E8 = 8mm width plastic tape  
E12 = 12mm width plastic tape  
\* Carrier tape 2mm pitch from one capacitor to another.



Capacitance-Temperature  
(temperature compensation)

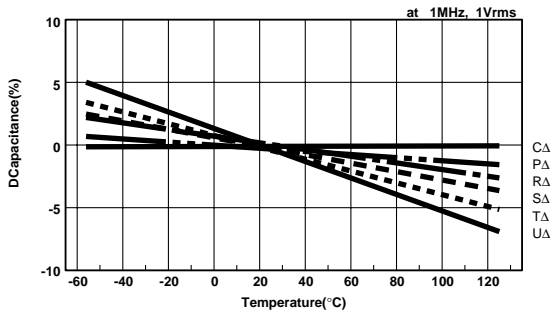

Aging  
(change of capacitance over time)

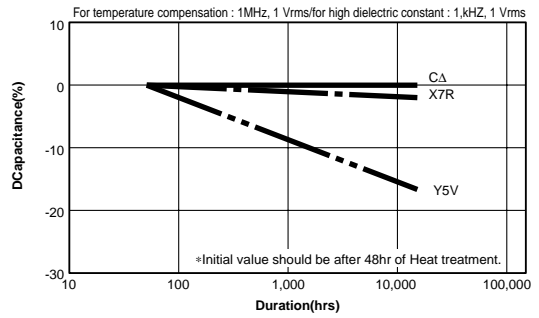

Capacitance-Temperature  
(high dielectric constant)

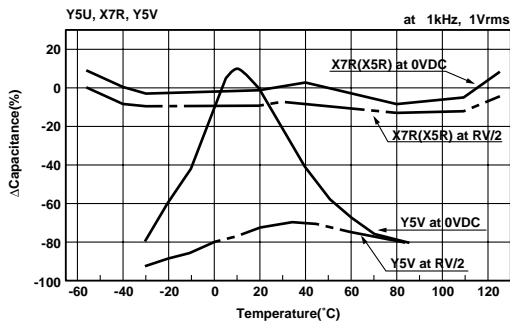

Impedance-Frequency

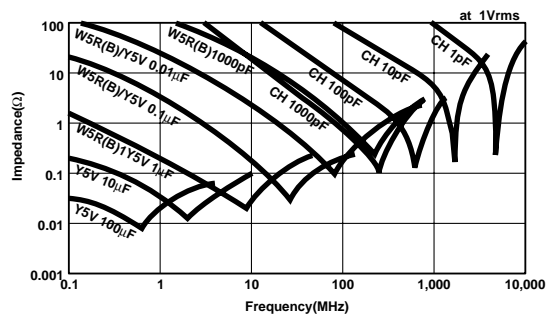

DC Bias

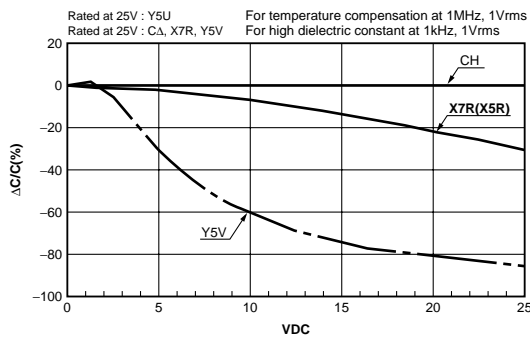

AC Voltage

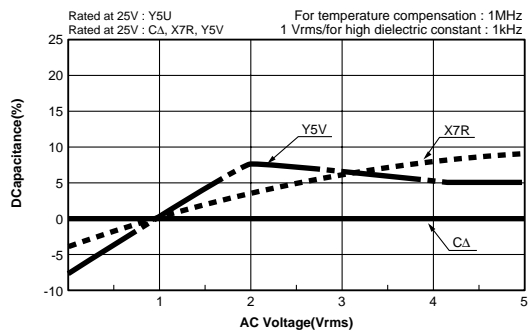

Please verify individual characteristics at the design stage to ensure total suitability

### Test conditions and Specification for Temperature Compensation type(C\* to U\* • SL characteristics)

Test Items		Specification (C: nominal capacitance)	Test Conditions											
Capacitance Value		Within tolerance	<table border="1"> <tr> <td>C≤1000pF</td> <td>1MHz±10%</td> <td>0.5 to</td> </tr> <tr> <td>C&gt;1000pF</td> <td>1kHz±10%</td> <td>5Vrms</td> </tr> </table>			C≤1000pF	1MHz±10%	0.5 to	C>1000pF	1kHz±10%	5Vrms			
C≤1000pF	1MHz±10%	0.5 to												
C>1000pF	1kHz±10%	5Vrms												
Q		C≥30pF: Q≥1000 C<30pF: Q≥400+20C												
Insulation resistance (IR) <sup>(※6)</sup>		10,000MΩ or 500MΩ•μF min, whichever is less	Measured after the rated voltage is applied for one minute at normal room temperature and humidity. (※4)											
Dielectric Resistance <sup>(※6)</sup>		No problem observed	(※1) Apply 3 times of the rated voltage for 1 to 5 seconds.											
Appearance		No problem observed	Microscope(10×magnification)											
Termination strength <sup>(※2)</sup>		No problem observed	Apply a sideward force of 500g(5N) <sup>(※7)</sup> to a PCB-mounted sample.											
Bending strength <sup>(※2)</sup>		No mechanical damage at 1mm bent	Glass epoxy PCB (t±1.6mm); fulcrum Spacing: 90mm; for 10 seconds.											
Vibration test	Appearance	No significant change is detected.	Vibration frequency: 10 to 55(Hz) Amplitude: 1.5mm Sweeping condition: 10→55→10Hz/min In X, Y and Z directions: 2 hours each Total 6 hours											
	ΔC	Within tolerance												
	Q	C≥30pF: Q≥1000 C<30pF: Q≥400+20C												
Soldering heat resistance	Appearance	No significant change is detected.	Soak the sample in 260°C±5°C solder for 10±0.5seconds and place in a room at normal temperature and humidity; measure after 24±2hours. (Preheating Conditions)											
	ΔC	±2.5% or ±0.25pF max, whichever is larger.												
	Q	C≥30pF: Q≥1000 C<30pF: Q≥400+20C												
	IR <sup>(※6)</sup>	10,000MΩ or 500MΩ•μF min, whichever is smaller												
	Withstand voltage <sup>(※6)</sup>	Resists without problem												
Solderability		Ni/Br termination: 90% min	Soaking Condition											
			<table border="1"> <tr> <th>Order</th> <th>Temperature</th> <th>Time</th> </tr> <tr> <td>1</td> <td>80 to 100°C</td> <td>2minutes</td> </tr> <tr> <td>2</td> <td>150 to 200°C</td> <td>2minutes</td> </tr> </table>			Order	Temperature	Time	1	80 to 100°C	2minutes	2	150 to 200°C	2minutes
Order	Temperature	Time												
1	80 to 100°C	2minutes												
2	150 to 200°C	2minutes												
			<table border="1"> <tr> <th>Sn63 Solder</th> <th>235±5°C</th> <th>2±0.5sec.</th> </tr> <tr> <th>Sn-3Ag-0.5Cu</th> <th>245±5°C</th> <th>3±0.5sec.</th> </tr> </table>			Sn63 Solder	235±5°C	2±0.5sec.	Sn-3Ag-0.5Cu	245±5°C	3±0.5sec.			
Sn63 Solder	235±5°C	2±0.5sec.												
Sn-3Ag-0.5Cu	245±5°C	3±0.5sec.												
Temperature cycle <sup>(※3)</sup>	Appearance	No significant change is detected.	(Cycle) Normal room temperature (3min)→ Lowest operation temperature (30min)→ Normal room temperature (3min)→ Highest operation temperature (30min)→  After five cycles (※3), measure after 24±2hours.											
	ΔC	±2.5% or ±0.25pF max, whichever is larger.												
	Q	C≥30pF: Q≥1000 C<30pF: Q≥400+20C												
	IR <sup>(※6)</sup>	10,000MΩ or 500MΩ•μF min, whichever is smaller												
	Withstand voltage <sup>(※6)</sup>	Resists without problem												
Humidity test <sup>(※5)</sup>	Appearance	No significant change is detected.	Measure the test sample after storing it 24±2hours at a temperature of 40°C±2°C and a relative humidity of 90-95% Rh. for 500+24/-0hours.											
	ΔC	±7.5% or ±0.75pF max, whichever is larger.												
	Q	C≥30pF: Q≥200 C<30pF: Q≥100+10C/3												
	IR <sup>(※6)</sup>	500MΩ or 25MΩ•μF min, whichever is smaller												
High-temperature with loading	Appearance	No significant change is detected.	After applying (※1) twice of the rated voltage at a temperature of 125±3°C for 1000+48/-0hours, measure the sample after storing 24±2hours.											
	ΔC	±3% or ±0.3pF max, whichever is larger.												
	Q	C≥30pF: Q≥350 10pF≤C<30pF: Q≥275+5C/2 C<10pF: Q≥200+10C												
	IR <sup>(※6)</sup>	1,000MΩ or 50MΩ•μF min, whichever is smaller												

\*1 For the CF series, use 1.5 times when the rated voltage is 250V; use/1.2 times when the rated voltage exceeds 630V.

\*2 Except CT series

\*3 Different specification for Nickel Barrier termination DN/DR series. (Alumina Substrate)

\*4 Apply 500V for 1minute in case the rated voltage is 1000V or higher.

\*5 Except CF series.

\*6 The charge and discharge current of the capacitor must not exceed 50mA.

\*7 2N at 0201 Size

### Test conditions and Specification for High Dielectric Type (X5R, X7R, Y5V)

Test Items		Specification		Test Condition											
		X7R/X5R	Y5V												
<b>Capacitance Value</b>		Within tolerance		Do previous treatment (*8, *14)											
<b>tanδ(%)</b>		2.5%max, 3.5%max (*2), 7.0%max (*12)	5.0%max, 7.0%max (*13)	<b>Capacitance</b>	<b>Fire</b>	<b>Vol</b>									
		5.0%max (*3), 7.5%max (*17)	9.0%max (*4), 12.5%max (*5)	C≤10μF	1kHz±10%	1.0±0.1Vrms									
<b>Insulation resistance (IR) (*15)</b>		10,000MΩ or 500MΩ•μF min, whichever is less		C>10μF											
<b>Dielectric Resistance (*15)</b>		No problem observed		120Hz±10%											
<b>Appearance</b>		No problem observed		0.5±0.1Vrms											
<b>Termination strength (*6)</b>		No problem observed		Measured after the rated voltage is applied for 2minutes at normal room temperature and humidity. (*10)											
<b>Bending strength test (*6)</b>		No problem observed at 1mm bent		(*1) Apply 2.5 times of the rated voltage for 1 to 5 seconds.											
<b>Vibration test</b>	<b>Appearance</b>	No significant change is detected.		Microscope(10×magnification)											
	<b>ΔC</b>	Within tolerance		Apply a sideward force of 500g(5N) (*16) to a PCB-mounted sample.											
	<b>tanδ(%)</b>	Satisfies the initial value.		Glass epoxy PCB (t=1.6mm); fulcrum Spacing: 90mm; for 10 seconds.											
<b>Soldering heat resistance</b>	<b>Appearance</b>	No significant change is detected.		Vibration frequency: 10 to 55(Hz) Amplitude: 1.5mm Sweeping condition: 10→55→10Hz/min In X, Y and Z directions: 2 hours each Total 6 hours											
	<b>ΔC</b>	Within ±7.5%	Within ±20%	Do previous treatment (*8) Soak the sample in 260°C±5°C solder for 10±0.5seconds and place in a room at normal temperature and humidity; measure after 48±4hours. (Preheating Conditions)											
	<b>tanδ(%)</b>	Satisfies the initial value.													
	<b>IR (*15)</b>	10,000MΩ or 500MΩ•μF min, whichever is smaller													
	<b>Withstand voltage (*15)</b>	Resists without problem													
<b>Solderability</b>		Ni/Br termination: 90% min		Soaking Condition											
<b>Temperature cycle (*7)</b>	<b>Appearance</b>	No significant change is detected.		<table border="1"> <thead> <tr> <th>Order</th> <th>Temperature</th> <th>Time</th> </tr> </thead> <tbody> <tr> <td>1</td> <td>80 to 100°C</td> <td>2minutes</td> </tr> <tr> <td>2</td> <td>150 to 200°C</td> <td>2minutes</td> </tr> </tbody> </table>			Order	Temperature	Time	1	80 to 100°C	2minutes	2	150 to 200°C	2minutes
	Order	Temperature	Time												
	1	80 to 100°C	2minutes												
	2	150 to 200°C	2minutes												
	<b>ΔC</b>	Within ±7.5%	Within ±20%	<table border="1"> <thead> <tr> <th>Sn63 Solder</th> <th>235±5°C</th> <th>2±0.5sec.</th> </tr> <tr> <th>Sn-3Ag-0.5Cu</th> <th>245±5°C</th> <th>3±0.5sec.</th> </tr> </thead> </table>			Sn63 Solder	235±5°C	2±0.5sec.	Sn-3Ag-0.5Cu	245±5°C	3±0.5sec.			
Sn63 Solder	235±5°C	2±0.5sec.													
Sn-3Ag-0.5Cu	245±5°C	3±0.5sec.													
<b>tanδ(%)</b>	Satisfies the initial value.		Do previous treatment (*8) (Cycle) Normal room temperature (3min)→ Lowest operation temperature (30min)→ Normal room temperature (3min)→ Highest operation temperature (30min)→												
<b>IR (*15)</b>	10,000MΩ or 500MΩ•μF min, whichever is smaller		After five cycles (*7), measure after 48±4hours.												
<b>Withstand voltage (*15)</b>	Resists without problem														
<b>Humidity test (*11)</b>	<b>Appearance</b>	No significant change is detected.		Do previous treatment (*9) After storing it at a temperature of 40°C±2°C and a relative humidity of 90-95% for 500+24/-0hours, measure the sample after storing 48±4hours.											
	<b>ΔC</b>	Within ±12.5%	Within ±30%												
	<b>tanδ(%)</b>	200% max of initial value	150% max of initial value												
	<b>IR (*15)</b>	500MΩ or 25MΩ•μF min, whichever is smaller													
<b>High-temperature with loading</b>	<b>Appearance</b>	No significant change is detected.		Do previous treatment (*9) After applying twice (*18) of the rated voltage at the highest operating temperature for 1000+48/-0hours, measure the sample after storing 48±4hours.											
	<b>ΔC</b>	Within ±12.5%	Within ±30%												
	<b>tanδ(%)</b>	200% max of initial value	150% max of initial value												
	<b>IR (*15)</b>	1,000MΩ or 50MΩ•μF min, whichever is smaller													

\*1 Use 1.5 times when the rated voltage is 250V or over.  
Use 1.2 times when the rated voltage is 630V or over.

\*2 Apply to X5R 35V type, X7R 16V/25V type.

\*3 Apply to X5R16V/25V type, X7R/X7S 6.3V/10V type.

\*4 Apply to Y5V 16V type, CM32Y5V335 to 106 (25V Type).

\*5 Apply to Y5V 6.3V/10V type. Apply 16% to CM21Y5V106/CM316Y5V226.

\*6 Exclude CT series with thickness of less than 0.66mm and CA series.

\*7 Different Specification for Nickel Barrier termination DN/DR series. (Alumina Substrate)

\*8 Keep specimen at 150°C+0/-10°C for one hour, leave specimen at room ambient for 48±4 hours.

\*9 Apply the same test condition for one hour, then leave the specimen at room ambient for 48±4 hours.

\*10 For the CF series over 1000V, apply 500V for 1 minutes at room ambient.

\*11 Except CF series.

\*12 Apply to X5R 10V type, X7S 4V type.

\*13 Apply to 25V series of CM105Y5V154 over, CM21Y5V105 over, 316Y5V155 over.

\*14 Measurement condition 1kHz, 1Vrms for Y5V, C < 47μF type.

\*15 The charge/discharge current of the capacitor must not exceed 50mA.

\*16 2N at 0201 Size

\*17 Apply to X5R 4V and 6.3V type.

\*18 Use 1.5times when the rated voltage is 4V/6.3V/10V/250V and 100V (32X7R474/43X7R105/55X7R105).

Use 1.2times when the rated voltage is 630V or over.

## Tape and Reel

### • Reel

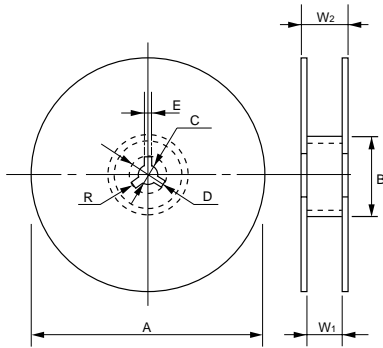

## Reel (code : T)

(Unit : mm)

Code Reel	A	B	C	D
7-inch Reel (CODE : T, H)	178±2.0	φ60min	13±0.5	21±0.8
13-inch Reel (CODE : L, N)	330±2.0	φ100±1.0		
Code Reel	E	W <sub>1</sub>	W <sub>2</sub>	R
7-inch Reel (CODE : T, H)	2.0±0.5	10.0±1.5	16.5max	1.0
13-inch Reel (CODE : L, N)		9.5±1.0		

\*Carrier tape width 8mm. For size 42(1808) or over, Tape width 12mm and W<sub>1</sub> : 14±1.5, W<sub>2</sub> : 18.4mm max

F=2mm(03, 05, 105 Type)

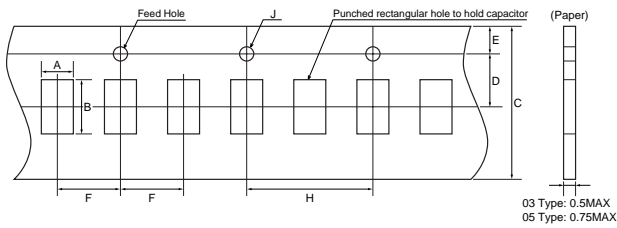

F=4mm(105, D11, D12, F12, F13, 21, 316, 32, 42, 52 Type)

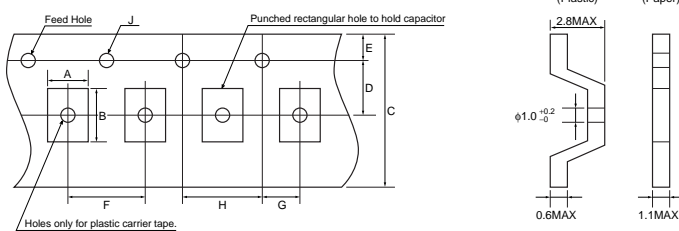

F=8mm(43, 53, 55 Type)

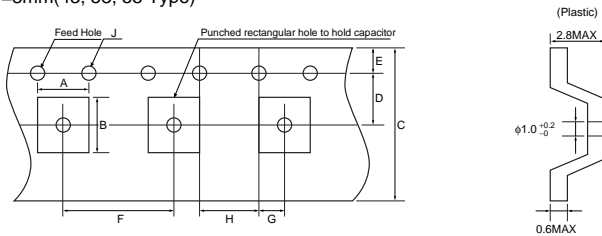

## Bulk Cassette

(Unit : mm)

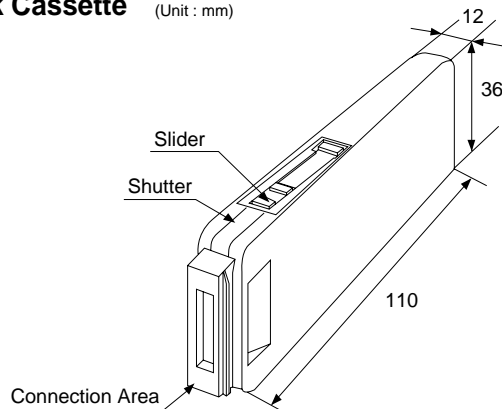

## Carrier Tape

(Unit : mm)

Type	A	B	F
<b>03 (0.6×0.3)</b>	0.37±0.03	0.67±0.03	2.0±0.05
<b>05 (1.0×0.5)</b>	0.65±0.1	1.15±0.1	2.0±0.05
<b>105 (1.6×0.8)</b>	1.0±0.2	1.8±0.2	4.0±0.1
<b>D11 (1.37×1.0)</b>	1.15±0.1	1.55±0.1	4.0±0.1
<b>D12 (1.25×2.0)</b>	1.5±0.2	2.3±0.2	4.0±0.1
<b>F12 (1.25×2.0)</b>	1.5±0.2	2.3±0.2	4.0±0.1
<b>F13 (1.6×3.2)</b>	2.0±0.2	3.6±0.2	4.0±0.1
<b>21 (2.0×1.25)</b>	1.5±0.2	2.3±0.2	4.0±0.1
<b>316 (3.2×1.6)</b>	2.0±0.2	3.6±0.2	4.0±0.1
<b>32 (3.2×2.5)</b>	2.9±0.2	3.6±0.2	4.0±0.1
<b>42 (4.5×2.0)</b>	2.4±0.2	4.9±0.2	4.0±0.1
<b>43 (4.5×3.2)</b>	3.6±0.2	4.9±0.2	8.0±0.1
<b>52 (5.7×2.0)</b>	2.4±0.2	6.0±0.2	4.0±0.1
<b>53 (5.7×2.8)</b>	3.2±0.2	6.0±0.2	8.0±0.1
<b>55 (5.7×5.0)</b>	5.3±0.2	6.0±0.2	8.0±0.1

(Unit : mm)

F	Carrier Tape	C	D	E	G	H	J
2.0±0.05	8mm Paper	8.0±0.3	3.5±0.05	1.75±0.1	2.0±0.05	4.0±0.1	1.5+0.1/-0
4.0±0.1	8mm Plastic						
8.0±0.1	12mm Plastic	12.0±0.3	5.5±0.05				

## Circuit Design

1. Once application and assembly environments have been checked, the capacitor may be used in conformance with the rating and performance which are provided in both the catalog and the specifications. Use exceeding that which is specified may result in inferior performance or cause a short, open, smoking, or flaming to occur, etc.
2. Please consult the manufacturer in advance when the capacitor is used in devices such as: devices which deal with human life, i.e. medical devices; devices which are highly public orientated; and devices which demand a high standard of liability.  
Accident or malfunction of devices such as medical devices, space equipment and devices having to do with atomic power could generate grave consequence with respect to human lives or, possibly, a portion of the public. Capacitors used in these devices may require high reliability design different from that of general purpose capacitors.
3. Please use the capacitors in conformance with the operating temperature provided in both the catalog and the specifications.  
Be especially cautious not to exceed the maximum temperature. In the situation the maximum temperature set forth in both the catalog and specifications is exceeded, the capacitor's insulation resistance may deteriorate, power may suddenly surge and short-circuit may occur.  
The capacitor has a loss, and may self-heat due to equivalent series resistance when alternating electric current is passed therethrough. As this effect becomes especially pronounced in high frequency circuits, please exercise caution.  
When using the capacitor in a (self-heating) circuit, please make sure the surface of the capacitor remains under the maximum temperature for usage. Also, please make certain temperature rises remain below 20°C.
4. Please keep voltage under the rated voltage which is applied to the capacitor. Also, please make certain the peak voltage remains below the rated voltage when AC voltage is super-imposed to the DC voltage.  
In the situation where AC or pulse voltage is employed, ensure average peak voltage does not exceed the rated voltage.  
Exceeding the rated voltage provided in both catalog and specifications may lead to defective withstanding voltage or, in worst case situations, may cause the capacitor to smoke or flame.
5. When the capacitor is to be employed in a circuit in which there is continuous application of a high frequency voltage or a steep pulse voltage, even though it is within the rated voltage, please inquire to the manufacturer.  
In the situation the capacitor is to be employed using a high frequency AC voltage or a extremely fast rising pulse voltage, even though it is within the rated voltage, it is possible capacitor reliability will deteriorate.
6. It is a common phenomenon of high-dielectric products to have a deteriorated amount of static electricity due to the application of DC voltage.  
Due caution is necessary as the degree of deterioration varies depending on the quality of capacitor materials, capacity, as well as the load voltage at the time of operation.
7. Do not use the capacitor in an environment where it might easily exceed the respective provisions concerning shock and vibration specified in the catalog and specifications.  
In addition, it is a common piezo phenomenon of high dielectric products to have some Voltage due to vibration or to have noise due to Voltage change. Please contact sales in such case.
8. If the electrostatic capacity value of the delivered capacitor is within the specified tolerance, please consider this when designing the respective product in order that the assembled product function appropriately.

## Storage

1. If the component is stored in minimal packaging (a heat-sealed or chuck-type plastic bag), the bag should be kept closed. Once the bag has been opened, reseal it or store it in a desiccator.
2. Keep storage place temperature +5 to +35 degree C, humidity 45 to 70% RH.
3. The storage atmosphere must be free of gas containing sulfur and chlorine. Also, avoid exposing the product to saline moisture. If the product is exposed to such atmospheres, the terminals will oxidize and solderability will be effected.
4. Precautions 1)-3) apply to chip capacitors packaged in carrier tapes and bulk cases.
5. The solderability is assured for 12 months from our shipping date (six months for silver palladium) if the above storage precautions are followed.
6. Chip capacitors may crack if exposed to hydrogen (H<sub>2</sub>) gas while sealed or if coated with silicon, which generates hydrogen gas.

## Dimensions for recommended typical land

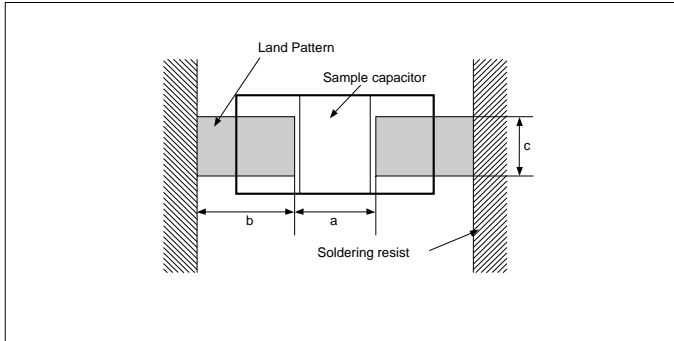

When mounting the capacitor to the substrate, it is important to consider carefully that the amount of solder (size of fillet) used has a direct effect upon the capacitor once it is mounted.

- The greater the amount of solder, the greater the stress to the elements. As this may cause the substrate to break or crack, it is important to establish the appropriate dimensions with regard to the amount of solder when designing the land of the substrate.
- In the situation where two or more devices are mounted onto a common land, separate the device into exclusive pads by using soldering resist

## Standard

(Unit : mm)

Size	L×W	a	b	c
03	0.6×0.3	0.20 to 0.30	0.25 to 0.35	0.30 to 0.40
05	1.0×0.5	0.30 to 0.50	0.35 to 0.45	0.40 to 0.60
105	1.6×0.8	0.70 to 1.00	0.80 to 1.00	0.60 to 0.80
21	2.0×1.25	1.00 to 1.30	1.00 to 1.20	0.80 to 1.10
316	3.2×1.6	2.10 to 2.50	1.10 to 1.30	1.00 to 1.30
32	3.2×2.5	2.10 to 2.50	1.10 to 1.30	1.90 to 2.30
42	4.5×2.0	2.50 to 3.20	1.80 to 2.30	1.50 to 1.80
43	4.5×3.2	2.50 to 3.20	1.80 to 2.30	2.60 to 3.00
52	5.7×2.0	4.20 to 4.70	2.00 to 2.50	1.50 to 1.80
53	5.7×2.8	4.20 to 4.70	2.00 to 2.50	2.20 to 2.60
55	5.7×5.0	4.20 to 4.70	2.00 to 2.50	4.20 to 4.70

\* CA series : Please refer Page 19.

## DN/DR Automotive Series

(Unit : mm)

Size	L×W	a	b	c
105	1.6×0.8	0.60 to 0.90	0.80 to 1.00	0.70 to 1.00
21	2.0×1.25	0.90 to 1.20	0.80 to 1.20	0.90 to 1.40
316	3.2×1.6	1.40 to 1.90	1.00 to 1.30	1.30 to 1.80

## Ideal Solder Thickness

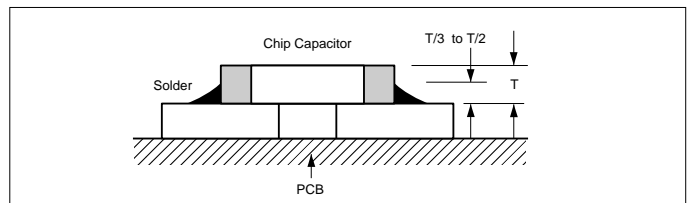

## Typical mounting problems

Item	Not recommended example	Recommended example/Separated by solder resist
Multiple parts mount		
Mount with leaded parts		
Wire soldering after mounting		
Overview		

## Mounting Design

The chip could crack if the PCB warps during processing after the chip has been soldered.

## Recommended chip position on PCB to minimize stress from PCB warpage



## Actual Mounting

- 1) If the position of the vacuum nozzle is too low, a large force may be applied to the chip capacitor during mounting, resulting in cracking.
- 2) During mounting, set the nozzle pressure to a static load of 100 to 300 gf.
- 3) To minimize the shock of the vacuum nozzle, provide a support pin on the back of the PCB to minimize PCB flexure.



- 4) When the positioning hook begins to wear, unstable mechanical shock may be applied to the chip capacitor, resulting in cracking.
- 5) To reduce the possibility of chipping and cracks, minimize vibration to chips stored in a bulk case.
- 6) The discharge pressure must be adjusted to the part size. Verify the pressure during setup to avoid fracturing or cracking the chips capacitors.

## Resin Mold

- 1) If a large amount of resin is used for molding the chip, cracks may occur due to contraction stress during curing. To avoid such cracks, use a low shrinkage resin.
- 2) The insulation resistance of the chip will degrade due to moisture absorption. Use a low moisture absorption resin.
- 3) Check carefully that the resin does not generate a decomposition gas or reaction gas during the curing process or during normal storage. Such gases may crack the chip capacitor or damage the device itself.

## Soldering Method

- 1) Ceramic is easily damaged by rapid heating or cooling. If some heat shock is unavoidable, preheat enough to limit the temperature difference ( $\Delta T$ ) to within 130 degree Celsius.
- 2) The product size 1.0×0.5mm to 3.2×1.6mm can be used in reflow and wave soldering, and the product size of over 3.2×2.5mm, 0.6×0.3mm, and capacitor arrays can be used in reflow.  
Circuit shortage and smoking can be created by using capacitors which are used neglecting the above caution.
- 3) Please see our recommended soldering conditions.  
Please contact us if you use lead free solder because the peak temperature of lead free is different from non-lead free.

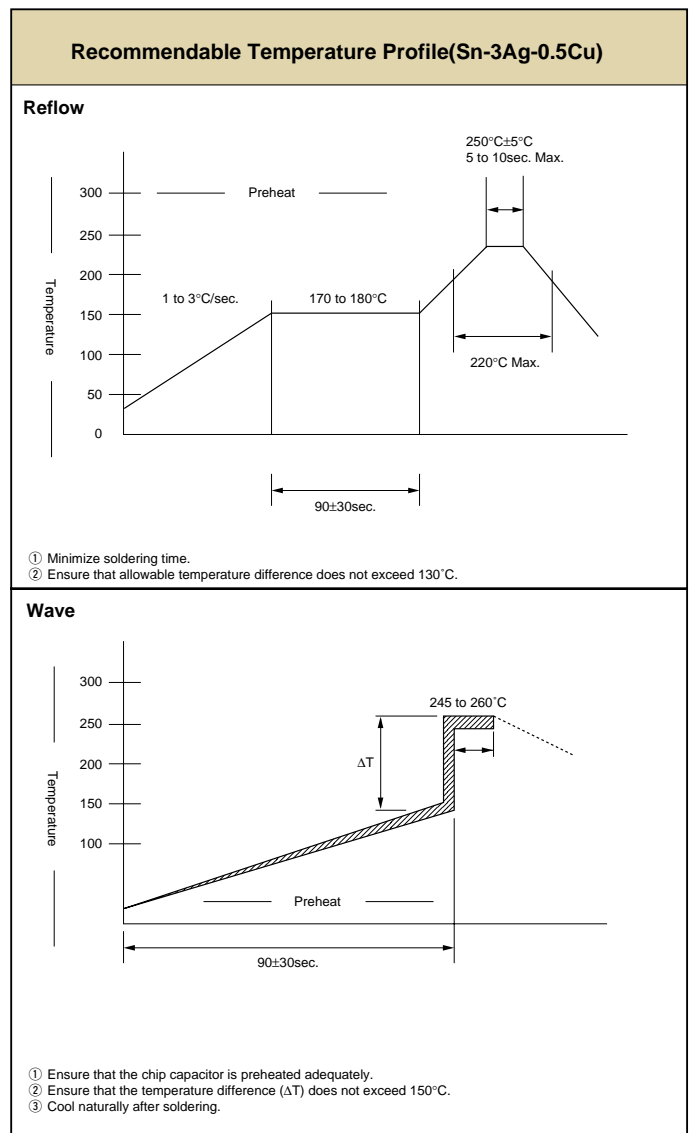
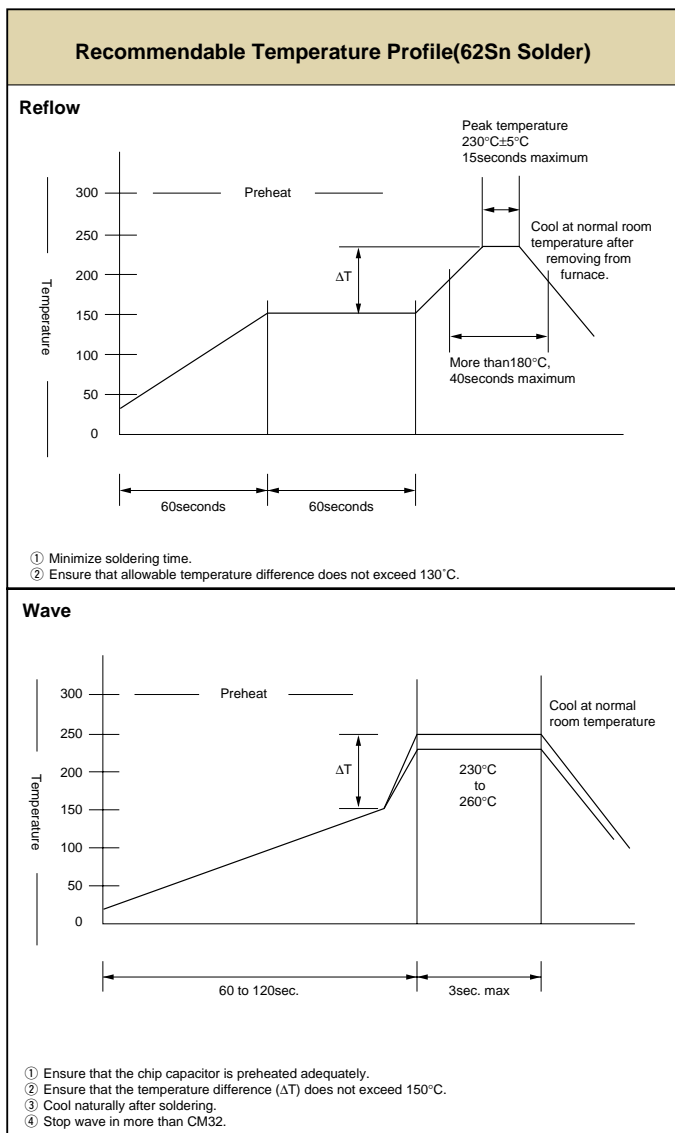

## Soldering iron

- |                                |            |                                                                                |
|--------------------------------|------------|--------------------------------------------------------------------------------|
| 1) Temperature of iron chip    | 350°C max  | 5) Cautions                                                                    |
| 2) Wattage                     | 30W max    | a) Pre-heating is necessary Rapid heating must be avoided.<br>Delta T ≤ 130°C. |
| 3) Tip shape of soldering iron | φ3.0mm max | b) Avoid direct touching to capacitors.                                        |
| 4) Soldering Time              | 3sec. max  | c) Avoid rapid cooling after soldering. Natural cooling is recommended.        |