



FAN6754

Highly Integrated Green- Mode PWM Controller

Brownout and V_{Limit} Adjustment by HV Pin

Features

- High-Voltage Startup
- AC Input Brownout Protection with Hysteresis
- Monitor HV to Adjust V_{Limit}
- Low Operating Current: 1.7mA
- Linearly Decreasing PWM Frequency to 22KHz
- Frequency Hopping to Reduce EMI Emission
- Fixed PWM Frequency: 65KHz
- Peak-Current-Mode Control
- Cycle-by-Cycle Current Limiting
- Leading-Edge Blanking (LEB)
- Internal Open-Loop Protection
- GATE Output Maximum Voltage Clamp: 13V
- V_{DD} Under-Voltage Lockout (UVLO)
- V_{DD} Over-Voltage Protection (OVP)
- Programmable Over-Temperature Protection (OTP)
- Latch Circuit (OVP, OTP)
- Open-Loop Protection (OLP); Restart for MR, Latch for ML
- Built-in 8ms Soft-Start Function

Applications

General-purpose switch-mode power supplies and flyback power converters, including:

- Power Adapters

Description

The highly integrated FAN6754 PWM controller provides several features to enhance the performance of flyback converters. To minimize standby power consumption, a proprietary green-mode function provides off-time modulation to continuously decrease the switching frequency under light-load conditions.

Under zero-load and very light-load conditions, FAN6754 saves PWM pulses by entering deep burst mode. This burst mode function enables the power supply to meet international power conservation requirements.

FAN6754 integrates a frequency-hopping function internally to reduce EMI emission of a power supply with minimum line filters. Built-in synchronized slope compensation is accomplished by proprietary HV monitor to adjust V_{Limit} for constant output power limit over universal AC input range. Also, the gate output is clamped at 13V to protect the external MOSFET from over-voltage damage.

Other protection functions include AC input brownout protection with hysteresis and V_{DD} over-voltage protection. For over-temperature protection, an external NTC thermistor can be applied to sense the external switcher's temperature. When V_{DD} OVP are activated, an internal latch circuit is used to latch-off the controller. The latch mode is reset when the V_{DD} supply is removed.

FAN6754 is available in an 8-pin SOP package.

Ordering Information

Part Number	Operating Temperature Range	Eco Status	Package	Packing Method
FAN6754MRMY	-40 to +105°C	Green	8-Pin, Small Outline Package (SOP)	Tape & Reel
FAN6754MLMY				

For Fairchild's definition of Eco Status, please visit: http://www.fairchildsemi.com/company/green/rohs_green.html.

Application Diagram

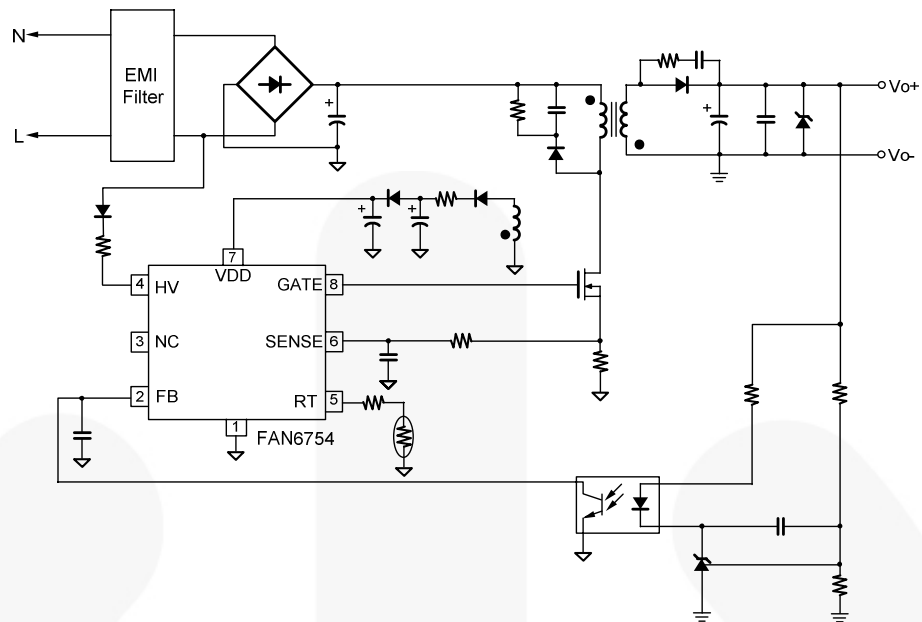

Figure 1. Typical Application

Internal Block Diagram

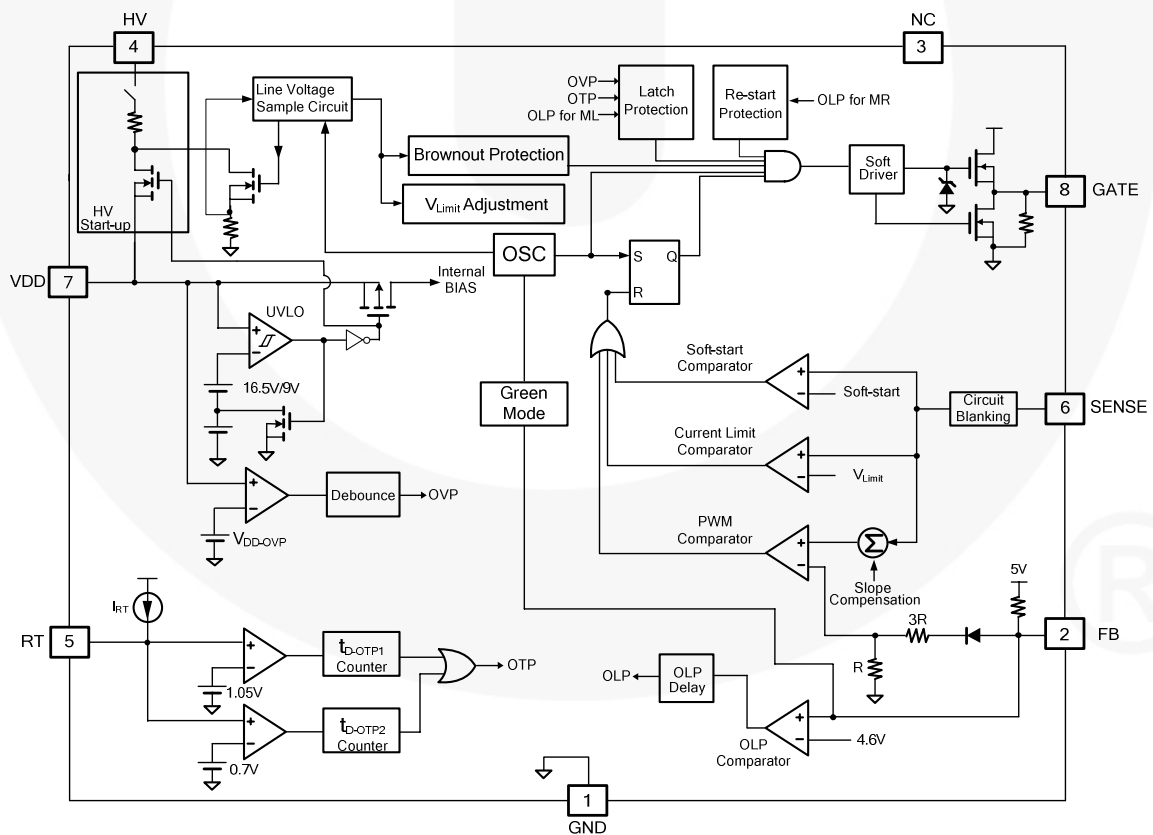

Figure 2. Functional Block Diagram

Marking Information

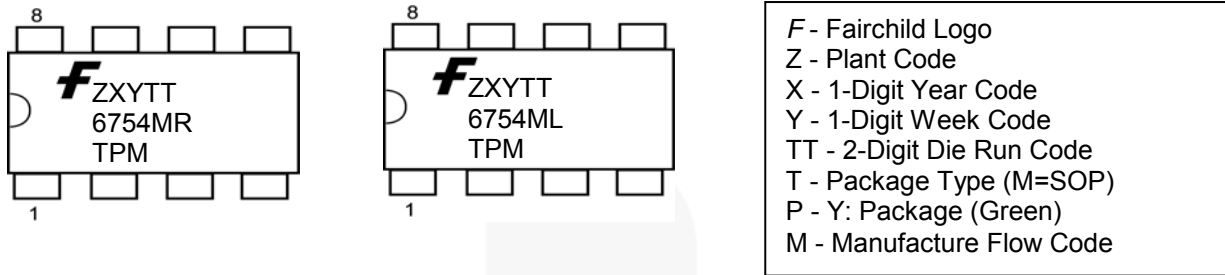

Figure 3. Top Mark

Pin Configuration

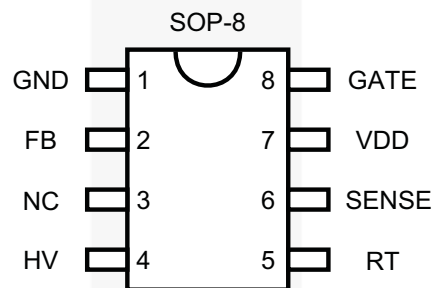

Figure 4. Pin Configuration (Top View)

Pin Definitions

Pin #	Name	Description
1	GND	Ground. This pin is used for the ground potential of all the pins. A 0.1 μ F decoupling capacitor placed between VDD and GND is recommended.
2	FB	Feedback. The output voltage feedback information from the external compensation circuit is fed into this pin. The PWM duty cycle is determined by this pin and the current-sense signal from Pin 6. FAN6754 performs an open-loop protection (OLP); if the FB voltage is higher than a threshold voltage (around 4.6V) for more than 55ms, the controller latches off the PWM.
3	NC	No Connection.
4	HV	High Voltage Startup. This pin is connected to the line input via a 1N4007 and 200k Ω resistors to achieve brownout and high/low line compensation. Once the voltage on the HV pin is lower than the brownout voltage, PWM output turns off. High/low line compensation dominates the cycle-by-cycle current limiting to achieve constant output power limiting with universal input.
5	RT	Over-Temperature Protection. An external NTC thermistor is connected from this pin to GND. The impedance of the NTC decreases at high temperatures. Once the voltage on the RT pin drops below the threshold voltage, the controller latches off the PWM.
6	SENSE	Current Sense. This pin is used to sense the MOSFET current for the current-mode PWM and current limiting.
7	VDD	Supply Voltage. IC operating current and MOSFET driving current are supplied using this pin. This pin is connected to an external bulk capacitor of typically 47 μ F. The threshold voltage for turn-on and turn-off is 16.5V and 9V, respectively. The operating current is lower than 2mA.
8	GATE	Gate Drive Output. The totem-pole output driver for the power MOSFET. It is internally clamped below 13V.

Absolute Maximum Ratings

Stresses exceeding the absolute maximum ratings may damage the device. The device may not function or be operable above the recommended operating conditions and stressing the parts to these levels is not recommended. In addition, extended exposure to stresses above the recommended operating conditions may affect device reliability. The absolute maximum ratings are stress ratings only.

Symbol	Parameter		Min.	Max.	Unit
V _{VDD}	DC Supply Voltage ^(1, 2)			30	V
V _{FB}	FB Pin Input Voltage		-0.3	7.0	V
V _{SENSE}	SENSE Pin Input Voltage		-0.3	7.0	V
V _{RT}	RT Pin Input Voltage		-0.3	7.0	V
V _{HV}	HV Pin Input Voltage			500	V
P _D	Power Dissipation (T _A < 50°C)			400	mW
θ _{JA}	Thermal Resistance (Junction-to-Air)			150	°C/W
T _J	Operating Junction Temperature		-40	+125	°C
T _{STG}	Storage Temperature Range		-55	+150	°C
T _L	Lead Temperature (Wave Soldering or IR, 10 Seconds)			+260	°C
ESD	Electrostatic Discharge Capability, All pins except HV pin	Human Body Model, JESD22-A114		4.5	kV
		Charged Device Model, JESD22-C101		1500	V

Notes:

- All voltage values, except differential voltages, are given with respect to the network ground terminal.
- Stresses beyond those listed under Absolute Maximum Ratings may cause permanent damage to the device.

Recommended Operating Conditions

The Recommended Operating Conditions table defines the conditions for actual device operation. Recommended operating conditions are specified to ensure optimal performance to the datasheet specifications. Fairchild does not recommend exceeding them or designing to Absolute Maximum Ratings.

Symbol	Parameter	Conditions	Min.	Typ.	Max.	Unit
T _A	Operating Ambient Temperature		-40		+105	°C
R _{HV}	HV Startup Resistor		150	200	250	kΩ

Electrical Characteristics

$V_{DD}=15V$ and $T_A=25^{\circ}C$ unless otherwise noted.

Symbol	Parameter	Conditions	Min.	Typ.	Max.	Units
V_{DD} Section						
V_{OP}	Continuously Operating Voltage				24	V
V_{DD-ON}	Start Threshold Voltage		15.5	16.5	17.5	V
V_{DD-OFF}	Minimum Operating Voltage		8	9	10	V
V_{DD-OLP}	I_{DD-OLP} Off Voltage		5.5	6.5	7.5	V
V_{DD-LH}	Threshold Voltage on VDD Pin for Latch-Off Release Voltage		3.5	4.0	4.5	V
V_{DD-AC}	Threshold Voltage on VDD Pin for Disable AC recovery to avoid Startup Failed		$V_{DD-OFF} + 2.5$	$V_{DD-OFF} + 3.0$	$V_{DD-OFF} + 3.5$	V
I_{DD-ST}	Startup Current	$V_{DD-ON} - 0.16V$			30	μA
I_{DD-OP1}	Operating Supply Current when PWM operation	$V_{DD}=20V$, FB=3V Gate Open		1.7	2.0	mA
I_{DD-OP2}	Operating Supply Current when Gate Stop	$V_{DD}=20V$, FB=3V		1.2	1.5	mA
I_{LH}	Operating Current at PWM-Off Phase Under Latch-Off Conduction	$V_{DD}=5V$	30	60	90	μA
I_{DD-OLP}	Internal Sink Current Under Latch-Off Conduction	$V_{DD-OLP}+0.1V$	170	200	230	μA
V_{DD-OVP}	V_{DD} Over-Voltage Protection		24	25	26	V
$t_{D-VDDOVP}$	V_{DD} Over-Voltage Protection Debounce Time		75	165	255	μs
HV Section						
I_{HV}	Supply Current from HV Pin	$V_{AC}=90V(V_{DC}=120V)$, $V_{DD}=0V$	1.50	2.75	4.00	mA
V_{AC-OFF}	Brownout Threshold	DC Source Series R=200k Ω to HV Pin See Equation 1	92	102	112	V
V_{AC-ON}	Brownin Threshold	DC Source Series R=200k Ω to HV Pin See Equation 2	104	114	124	V
ΔV_{AC}	$V_{AC-ON} - V_{AC-OFF}$	DC Source Series R=200k Ω to HV Pin	6	12	18	V
$t_{S-CYCLE}$	Line Voltage Sample Cycle	FB > V_{FB-N}		220		μs
		FB < V_{FB-G}		650		
t_{H-TIME}	Line Voltage Hold Period			20		μs
$t_{D-AC-OFF}$	PWM Turn-off Debounce Time	FB > V_{FB-N}	65	75	85	ms
		FB < V_{FB-G}	180	235	290	ms

Continued on the following page...

Electrical Characteristics (Continued)

$V_{DD}=15V$ and $T_A=25^{\circ}C$ unless otherwise noted.

Symbol	Parameter	Conditions	Min.	Typ.	Max.	Units
Oscillator Section						
f_{OSC}	Frequency in Normal Mode	Center Frequency	61	65	69	KHz
		Hopping Range	± 3.7	± 4.2	± 4.7	
t_{HOP}	Hopping Period	$FB > V_{FB-N}$	3.9	4.4	4.9	ms
		$FB = V_{FB-G}$	10.2	11.5	12.8	ms
f_{OSC-G}	Green-Mode Frequency		19	22	25	KHz
f_{DV}	Frequency Variation vs. V_{DD} Deviation	$V_{DD}=11V$ to $22V$			5	%
f_{DT}	Frequency Variation vs. Temperature Deviation	$T_A=-40$ to $+105^{\circ}C$			5	%
Feedback Input Section						
A_V	Input Voltage to Current-Sense Attenuation		1/4.5	1/4.0	1/3.5	V/V
Z_{FB}	Input Impedance		14	16	18	k Ω
$V_{FB-OPEN}$	Output High Voltage	FB Pin Open	4.8	5.0	5.2	V
V_{FB-OLP}	FB Open-Loop Trigger Level		4.3	4.6	4.9	V
t_{D-OLP}	Delay Time of FB Pin Open-Loop Protection		50	55	60	ms
V_{FB-N}	Green-Mode Entry FB Voltage	Pin, FB Voltage ($FB = V_{FB-N}$)	2.6	2.8	3.0	V
		Hopping Range	± 3.7	± 4.2	± 4.7	kHz
V_{FB-G}	Green-Mode Ending FB Voltage	Pin, FB Voltage ($FB = V_{FB-G}$)	2.1	2.3	2.5	V
		Hopping Range	± 1.27	± 1.45	± 1.62	kHz
$V_{FB-ZDCR}$	FB Threshold Voltage for Zero-Duty Recovery		1.9	2.1	2.3	V
V_{FB-ZDC}	FB Threshold Voltage for Zero-Duty		1.8	2.0	2.2	V

Continued on the following page...

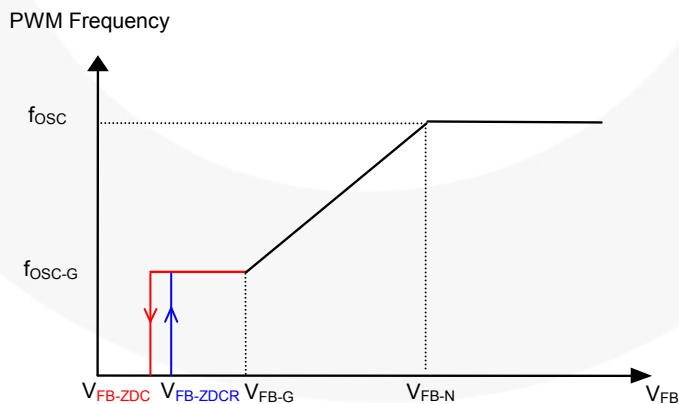

Figure 5. V_{FB} vs. PWM Frequency

Electrical Characteristics (Continued)

$V_{DD}=15V$ and $T_A=25^{\circ}C$ unless otherwise noted.

Symbol	Parameter	Conditions	Min.	Typ.	Max.	Units
Current-Sense Section						
t_{PD}	Delay to Output			100	250	ns
t_{LEB}	Leading Edge Blanking Time		230	280	330	ns
$V_{Limit-L}$	Current Limit at Low Line ($V_{AC}=86V$)	$V_{DC}=122V$, Series R=200k Ω to HV	0.43	0.46	0.49	V
$V_{Limit-H}$	Current Limit at High Line ($V_{AC}=259V$)	$V_{DC}=366V$, Series R=200k Ω to HV	0.36	0.39	0.42	V
t_{SS}	Period During Soft-Start Time	Startup Time	7	8	9	ms
GATE Section						
DCY_{MAX}	Maximum Duty Cycle		86	89	92	%
V_{GATE-L}	Gate Low Voltage	$V_{DD}=15V$, $I_O=50mA$			1.5	V
V_{GATE-H}	Gate High Voltage	$V_{DD}=12V$, $I_O=50mA$	8			V
t_r	Gate Rising Time	$V_{DD}=15V$, $C_L=1nF$		100		ns
t_f	Gate Falling Time	$V_{DD}=15V$, $C_L=1nF$		50		ns
$V_{GATE-CLAMP}$	Gate Output Clamping Voltage	$V_{DD}=22V$	9	13	17	V
RT Section						
R_{RT}	Internal Resistor from RT Pin		9.50	10.55	11.60	K Ω
V_{RTTH1}	Over-Temperature Protection Threshold Voltage	$0.7V < V_{RT} < 1.05V$, after 12ms Latch Off	1.000	1.035	1.070	V
V_{RTTH2}		$V_{RT} < 0.7V$, After 100 μs Latch Off	0.65	0.70	0.75	V
t_{D-OTP1}	Over-Temperature Latch-Off Debounce	$V_{RTTH2} < V_{RT} < V_{RTTH1}$ $FB > V_{FB-N}$	14	16	18	ms
		$V_{RTTH2} < V_{RT} < V_{RTTH1}$ $FB < V_{FB-G}$	40	51	62	
t_{D-OTP2}		$V_{RT} < V_{RTTH2}$, $FB > V_{FB-N}$	110	185	260	μs
		$V_{RT} < V_{RTTH2}$, $FB < V_{FB-G}$	320	605	890	

Electrical Characteristics (Continued)

$V_{DD}=15V$ and $T_A=25^\circ C$ unless otherwise noted.

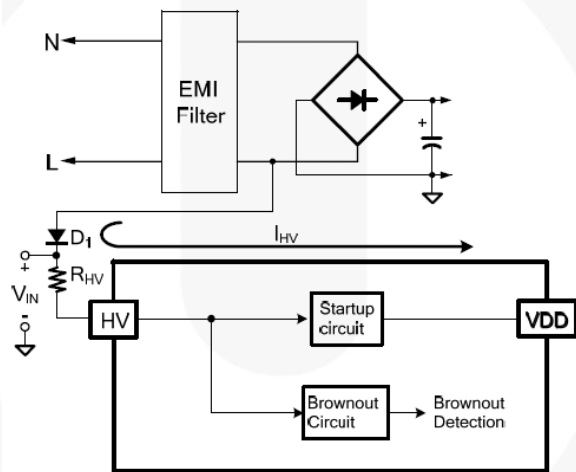

Figure 6. Brownout Circuit

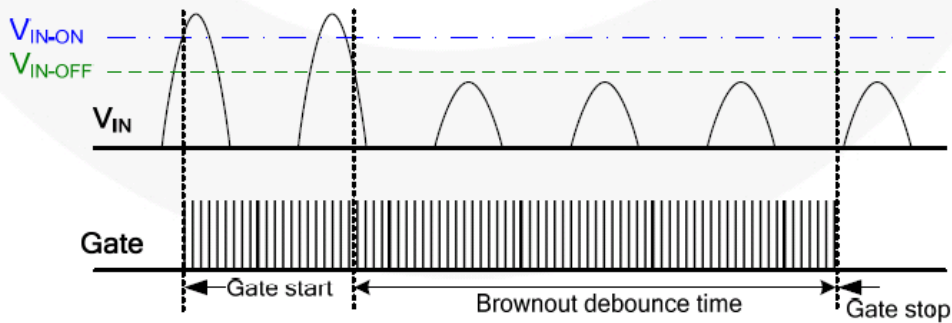

Figure 7. Brownout Behavior

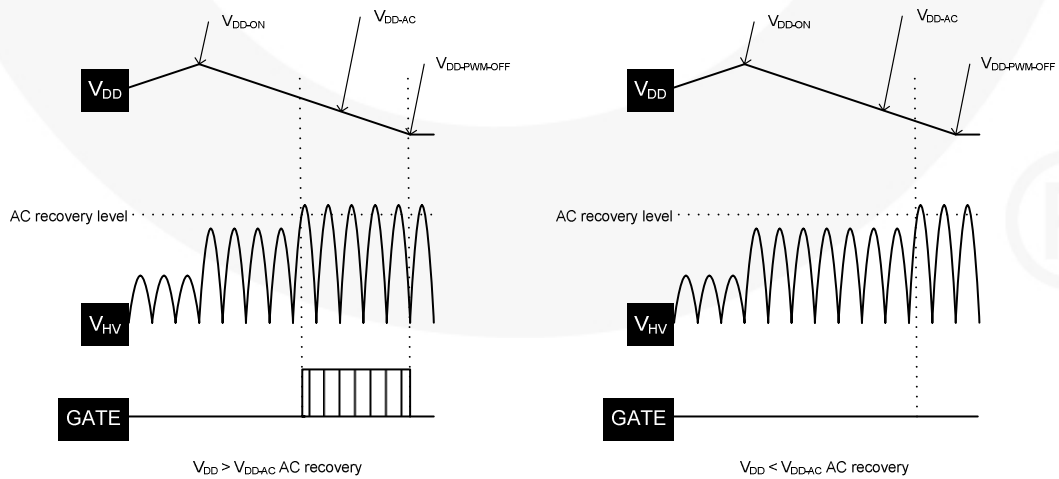

Figure 8. V_{DD-AC} and AC Recovery

Typical Performance Characteristics

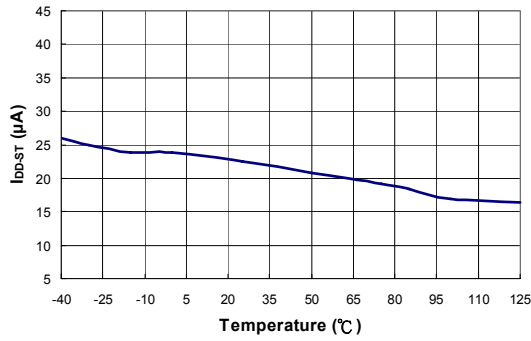

Figure 9. Startup Current (I_{DD-ST}) vs. Temperature

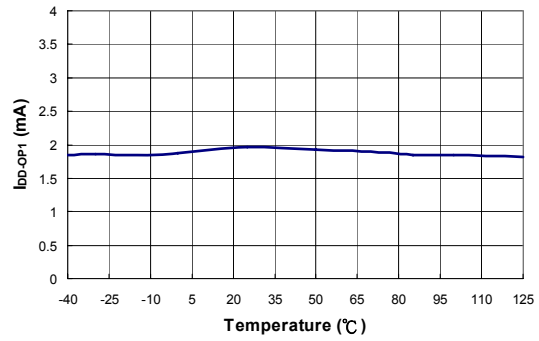

Figure 10. Operation Supply Current (I_{DD-OP1}) vs. Temperature

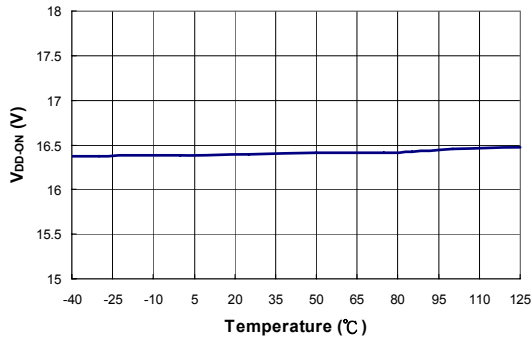

Figure 11. Start Threshold Voltage (V_{DD-ON}) vs. Temperature

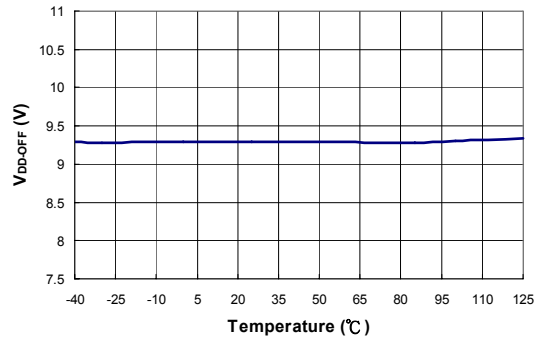

Figure 12. Minimum Operating Voltage (V_{DD-OFF}) vs. Temperature

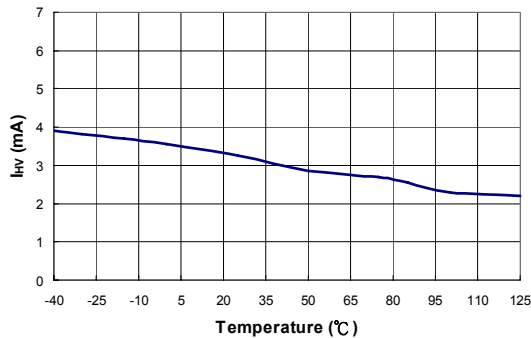

Figure 13. Supply Current Drawn from HV Pin (I_{HV}) vs. Temperature

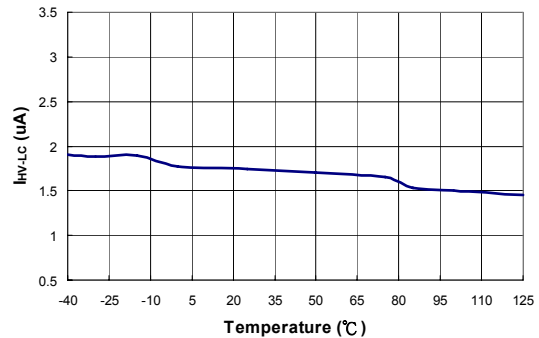

Figure 14. HV Pin Leakage Current After Startup (I_{HV-LC}) vs. Temperature

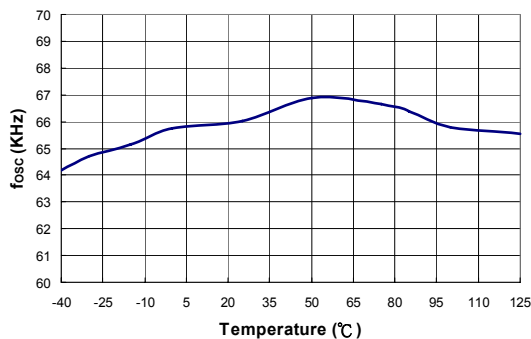

Figure 15. Frequency in Normal Mode (f_{OSC}) vs. Temperature

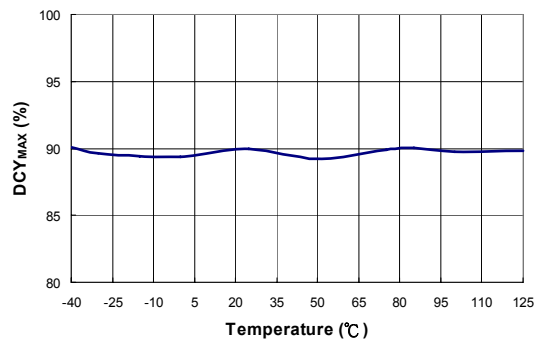

Figure 16. Maximum Duty Cycle (DCY_{MAX}) vs. Temperature

Typical Performance Characteristics (Continued)

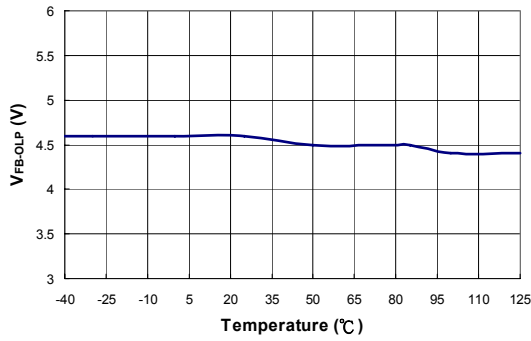

Figure 17. FB Open-Loop Trigger Level (V_{FB-OLP}) vs. Temperature

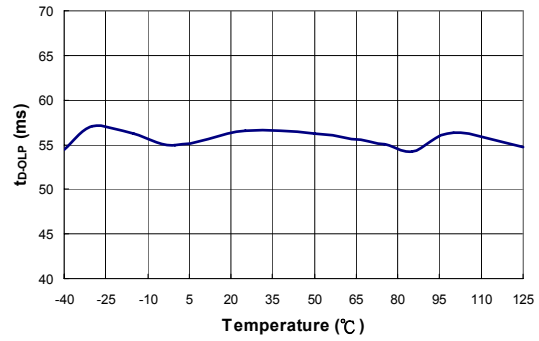

Figure 18. Delay Time of FB Pin Open-Loop Protection (t_{D-OLP}) vs. Temperature

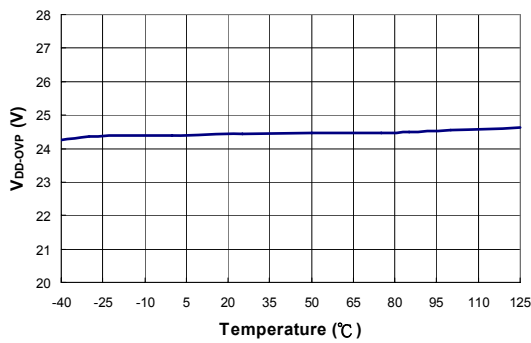

Figure 19. V_{DD} Over-Voltage Protection (V_{DD-OVP}) vs. Temperature

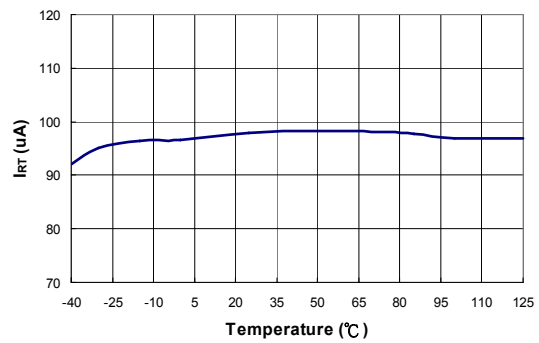

Figure 20. Output Current from RT Pin (I_{RT}) vs. Temperature

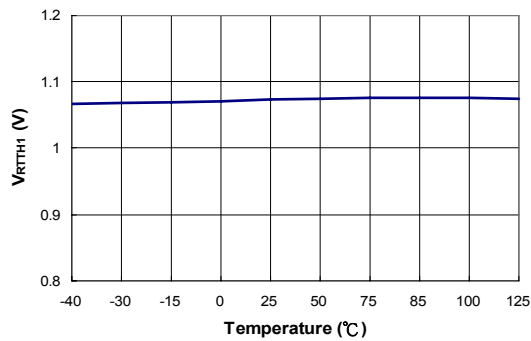

Figure 21. Over-Temperature Protection Threshold Voltage (V_{RTTH1}) vs. Temperature

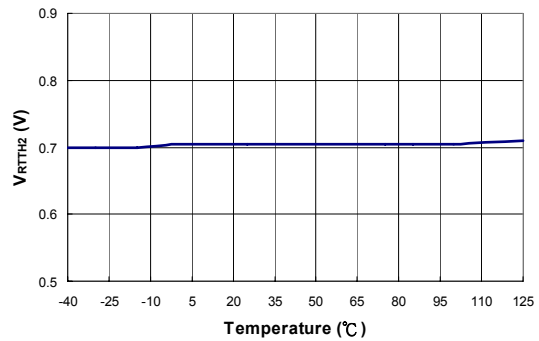

Figure 22. Over-Temperature Protection Threshold Voltage (V_{RTTH2}) vs. Temperature

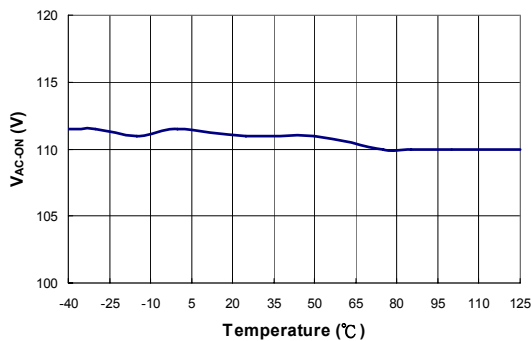

Figure 23. Brown-in (V_{AC-ON}) vs. Temperature

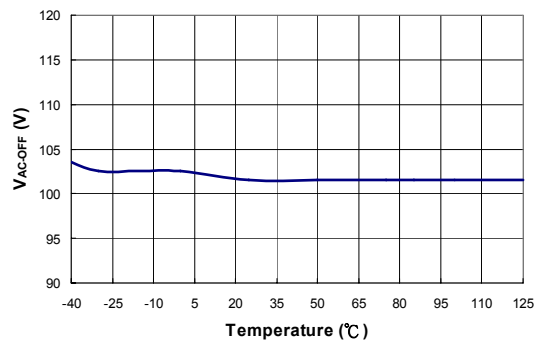

Figure 24. Brownout (V_{AC-OFF}) vs. Temperature

Functional Description

Startup Current

For startup, the HV pin is connected to the line input through an external diode and resistor; R_{HV} , (1N4007 / 150K Ω recommended). Peak startup current drawn from the HV pin is $(V_{AC} \times \sqrt{2}) / R_{HV}$ and charges the hold-up capacitor through the diode and resistor. When the V_{DD} capacitor level reaches V_{DD-ON} , the startup current switches off. At this moment, the V_{DD} capacitor only supplies the FAN6754 to keep the V_{DD} until the auxiliary winding of the main transformer provides the operating current.

Operating Current

Operating current is around 1.7mA. The low operating current enables better efficiency and reduces the requirement of V_{DD} hold-up capacitance.

Green-Mode Operation

The proprietary green-mode function provides off-time modulation to reduce the switching frequency in light-load and no-load conditions. V_{FB} , which is derived from the voltage feedback loop, is taken as the reference. Once V_{FB} is lower than the threshold voltage (V_{FB-N}), switching frequency is continuously decreased to the minimum green-mode frequency of around 22KHz.

Current Sensing / PWM Current Limiting

Peak-current-mode control is utilized to regulate output voltage and provide pulse-by-pulse current limiting. The switch current is detected by a sense resistor into the SENSE pin. The PWM duty cycle is determined by this current-sense signal and V_{FB} , the feedback voltage. When the voltage on the SENSE pin reaches around $V_{COMP} = (V_{FB} - 0.6) / 4$, the switch cycle is terminated immediately. V_{COMP} is internally clamped to a variable voltage around 0.46V for low-line output power limit.

Leading-Edge Blanking (LEB)

Each time the power MOSFET is switched on, a turn-on spike occurs on the sense-resistor. To avoid premature termination of the switching pulse, a leading-edge blanking time is built in. During this blanking period, the current-limit comparator is disabled and cannot switch off the gate driver.

Under-Voltage Lockout (UVLO)

The turn-on and turn-off thresholds are fixed internally at 16.5V and 9V, respectively. During startup, the hold-up capacitor must be charged to 16.5V through the startup resistor to enable the IC. The hold-up capacitor continues to supply V_{DD} until the energy can be delivered from auxiliary winding of the main transformer. V_{DD} must not drop below 9V during startup. This UVLO hysteresis window ensures that hold-up capacitor is adequate to supply V_{DD} during startup.

Gate Output / Soft Driving

The BiCMOS output stage is a fast totem-pole gate driver. Cross conduction has been avoided to minimize heat dissipation, increase efficiency, and enhance reliability. The output driver is clamped by an internal 13V Zener diode to protect power MOSFET transistors against undesirable gate over voltage. A soft driving waveform is implemented to minimize EMI.

Soft-Start

For many applications, it is necessary to minimize the inrush current at startup. The built-in 8ms soft-start circuit significantly reduces the startup current spike and output voltage overshoot.

Slope Compensation

The sensed voltage across the current-sense resistor is used for peak-current-mode control and cycle-by-cycle current limiting. Built-in slope compensation improves stability and prevents sub-harmonic oscillation. FAN6754 inserts a synchronized, positive-going, ramp at every switching cycle.

Constant Output Power Limit

When the SENSE voltage across sense resistor R_{SENSE} reaches the threshold voltage, around 0.46V for low-line condition, the output GATE drive is turned off after a small delay, t_{PD} . This delay introduces an additional current proportional to $t_{PD} \cdot V_{IN} / L_P$. Since the delay is nearly constant regardless of the input voltage V_{IN} , higher input voltage results in a larger additional current and the output power limit is higher than under low input line voltage. To compensate this variation for a wide AC input range, a power-limiter is controlled by the HV pin to solve the unequal power-limit problem. The power limiter is fed to the inverting input of the current limiting comparator. This results in a lower current limit at high-line inputs than at low-line inputs.

Brownout and Constant Power Limited by HV Pin

Unlike previous PWM controllers, FAN6754's HV pin can detect the AC line voltage brownout function and adjust the current limit level. Using a fast diode and startup resistor to sample the AC line voltage, the peak value refreshes and is stored in a register at each sampling cycle. When internal update time is met, this peak value is used for brownout and current-limit level judgment. Equation 1 and 2 calculate the level of brownin or brownout converted to RMS value. For power saving, FAN6754 enlarges the sampling cycle to lower the power loss from HV sampling at light load condition.

$$V_{AC-ON}(RMS) = (0.9V \times \frac{(R_{HV} + 1.6)}{1.6}) / \sqrt{2} \quad (1)$$

$$V_{AC-OFF}(RMS) = (0.81V \times \frac{(R_{HV} + 1.6)}{1.6}) / \sqrt{2} ; \text{ the unit of } R_{HV} \text{ is } K\Omega \quad (2)$$

The HV pin can perform current limit to shrink the tolerance of OCP (Over-Current Protection) under full range of AC voltage, to linearly current limit curve as shown in Figure 25. FAN6754 also shrinks the V_{limit} level by half to lower the I^2R_{SENSE} loss to increase the heavy-load efficiency.

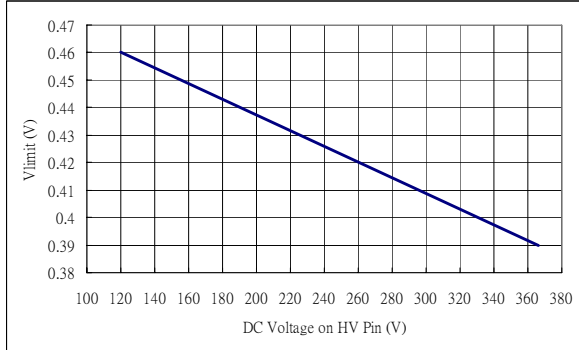

Figure 25. Linearly Current Limit Curve

V_{DD} Over-Voltage Protection (OVP)

V_{DD} over-voltage protection prevents damage due to abnormal conditions. If the V_{DD} voltage is over the over-voltage protection voltage (V_{DD-OVP}) and lasts for t_{D-VDDOVP}, the PWM pulses are disabled until the V_{DD} voltage drops below the UVLO, then starts again. Over-voltage conditions are usually caused by open feedback loops.

Thermal Protection

An NTC thermistor, R_{NTC}, in series with resistor R_A, can be connected from the RT pin to ground. A constant current I_{RT} is output from the RT pin. The voltage on the RT pin can be expressed as $V_{RT} = I_{RT} \cdot (R_{NTC} + R_{PTC})$, where I_{RT} is 100μA. At high ambient temperature, R_{NTC} is smaller, such that V_{RT} decreases. When V_{RT} is less than 1.035V (V_{RTTH1}), the PWM turns off after 16ms (t_{D-OTP1}). If V_{RT} is less than 0.7V (V_{RTTH2}), PWM turns off after 185μs (t_{D-OTP2}).

Limited Power Control

The FB voltage increases every time the output of the power supply is shorted or overloaded. If the FB voltage remains higher than a built-in threshold for longer than t_{D-OLP}, PWM output is turned off. As PWM output is turned off, V_{DD} begins decreasing.

When V_{DD} goes below the turn-off threshold (9V) the controller is totally shut down and, V_{DD} is continuously discharged to V_{DD-OLP} (6.5V) by I_{DD-OLP} to lower the average input power. This is called two-level UVLO. V_{DD} is cycled again. This protection feature continues as long as the overloading condition persists. This prevents the power supply from overheating due to overloading conditions.

Noise Immunity

Noise on the current sense or control signal may cause significant pulse-width jitter, particularly in continuous-conduction mode. Slope compensation helps alleviate this problem. Good placement and layout practices should be followed. Avoiding long PCB traces and component leads, locating compensation and filter components near the FAN6754, and increasing the power MOS gate resistance improve performance.



TRADEMARKS

The following includes registered and unregistered trademarks and service marks, owned by Fairchild Semiconductor and/or its global subsidiaries, and is not intended to be an exhaustive list of all such trademarks.

- | | | | |
|--------------------------|--|---------------------------------------|------------------|
| AccuPower™ | F-PFS™ | OPTOPLANAR® | SYSTEM GENERAL® |
| AttitudeEngine™ | FRFET® | Power Supply WebDesigner™ | TinyBoost® |
| Awinda® | Global Power Resource SM | PowerTrench® | TinyBuck® |
| AX-CAP®* | GreenBridge™ | PowerXS™ | TinyCalc™ |
| BitSiC™ | Green FPS™ | Programmable Active Droop™ | TinyLogic® |
| Build it Now™ | Green FPS™ e-Series™ | QFET® | TINYOPTO™ |
| CorePLUS™ | Gmax™ | QS™ | TinyPower™ |
| CorePOWER™ | GTO™ | Quiet Series™ | TinyPWM™ |
| CROSSVOL™ | IntelliMAX™ | RapidConfigure™ | TinyWire™ |
| CTL™ | ISOPLANAR™ | Saving our world, 1mW/W/kW at a time™ | TranSiC™ |
| Current Transfer Logic™ | Making Small Speakers Sound Louder and Better™ | SignalWise™ | TriFault Detect™ |
| DEUXPEED® | MegaBuck™ | SmartMax™ | TRUECURRENT®* |
| Dual Cool™ | MICROCOUPLER™ | SMART START™ | μSerDes™ |
| EcoSPARK® | MicroFET™ | Solutions for Your Success™ | UHC® |
| EfficientMax™ | MicroPak™ | SPM® | Ultra FRFET™ |
| ESBC™ | MicroPak2™ | STEALTH™ | UniFET™ |
| F [®] | MillerDrive™ | SuperFET® | VCX™ |
| Fairchild® | MotionMax™ | SuperSOT™-3 | VisualMax™ |
| Fairchild Semiconductor® | MotionGrid® | SuperSOT™-6 | VoltagePlus™ |
| FACT Quiet Series™ | MTi® | SuperSOT™-8 | XST™ |
| FACT® | MTx® | SupreMOS® | Xsens™ |
| FastvCore™ | MVN® | SyncFET™ | 仙童™ |
| FETBench™ | mWSaver® | Sync-Lock™ | |
| FPS™ | OptoHiT™ | | |
| | OPTOLOGIC® | | |

* Trademarks of System General Corporation, used under license by Fairchild Semiconductor.

DISCLAIMER

FAIRCHILD SEMICONDUCTOR RESERVES THE RIGHT TO MAKE CHANGES WITHOUT FURTHER NOTICE TO ANY PRODUCTS HEREIN TO IMPROVE RELIABILITY, FUNCTION, OR DESIGN. TO OBTAIN THE LATEST, MOST UP-TO-DATE DATASHEET AND PRODUCT INFORMATION, VISIT OUR WEBSITE AT [HTTP://WWW.FAIRCHILDSEMI.COM](http://www.fairchildsemi.com). FAIRCHILD DOES NOT ASSUME ANY LIABILITY ARISING OUT OF THE APPLICATION OR USE OF ANY PRODUCT OR CIRCUIT DESCRIBED HEREIN; NEITHER DOES IT CONVEY ANY LICENSE UNDER ITS PATENT RIGHTS, NOR THE RIGHTS OF OTHERS. THESE SPECIFICATIONS DO NOT EXPAND THE TERMS OF FAIRCHILD'S WORLDWIDE TERMS AND CONDITIONS, SPECIFICALLY THE WARRANTY THEREIN, WHICH COVERS THESE PRODUCTS.

AUTHORIZED USE

Unless otherwise specified in this data sheet, this product is a standard commercial product and is not intended for use in applications that require extraordinary levels of quality and reliability. This product may not be used in the following applications, unless specifically approved in writing by a Fairchild officer: (1) automotive or other transportation, (2) military/aerospace, (3) any safety critical application – including life critical medical equipment – where the failure of the Fairchild product reasonably would be expected to result in personal injury, death or property damage. Customer's use of this product is subject to agreement of this Authorized Use policy. In the event of an unauthorized use of Fairchild's product, Fairchild accepts no liability in the event of product failure. In other respects, this product shall be subject to Fairchild's Worldwide Terms and Conditions of Sale, unless a separate agreement has been signed by both Parties.

ANTI-COUNTERFEITING POLICY

Fairchild Semiconductor Corporation's Anti-Counterfeiting Policy. Fairchild's Anti-Counterfeiting Policy is also stated on our external website, www.fairchildsemi.com, under Terms of Use

Counterfeiting of semiconductor parts is a growing problem in the industry. All manufacturers of semiconductor products are experiencing counterfeiting of their parts. Customers who inadvertently purchase counterfeit parts experience many problems such as loss of brand reputation, substandard performance, failed applications, and increased cost of production and manufacturing delays. Fairchild is taking strong measures to protect ourselves and our customers from the proliferation of counterfeit parts. Fairchild strongly encourages customers to purchase Fairchild parts either directly from Fairchild or from Authorized Fairchild Distributors who are listed by country on our web page cited above. Products customers buy either from Fairchild directly or from Authorized Fairchild Distributors are genuine parts, have full traceability, meet Fairchild's quality standards for handling and storage and provide access to Fairchild's full range of up-to-date technical and product information. Fairchild and our Authorized Distributors will stand behind all warranties and will appropriately address any warranty issues that may arise. Fairchild will not provide any warranty coverage or other assistance for parts bought from Unauthorized Sources. Fairchild is committed to combat this global problem and encourage our customers to do their part in stopping this practice by buying direct or from authorized distributors.

PRODUCT STATUS DEFINITIONS

Definition of Terms

Datasheet Identification	Product Status	Definition
Advance Information	Formative / In Design	Datasheet contains the design specifications for product development. Specifications may change in any manner without notice.
Preliminary	First Production	Datasheet contains preliminary data; supplementary data will be published at a later date. Fairchild Semiconductor reserves the right to make changes at any time without notice to improve design.
No Identification Needed	Full Production	Datasheet contains final specifications. Fairchild Semiconductor reserves the right to make changes at any time without notice to improve the design.
Obsolete	Not In Production	Datasheet contains specifications on a product that is discontinued by Fairchild Semiconductor. The datasheet is for reference information only.

Rev. I76