

FEATURES

Offset voltage: 2.5 mV maximum
Single-supply operation: 2.7 V to 5.5 V
Low noise: 8 nV/√Hz
Wide bandwidth: 24 MHz
Slew rate: 11 V/μs
Short-circuit output current: 120 mA
Qualified for automotive applications
No phase reversal
Low input bias current: 1 pA
Low supply current per amplifier: 2 mA maximum
Unity gain stable

APPLICATIONS

Battery-powered instruments
Multipole filters
ADC front ends
Sensors
Barcode scanners
ASIC input or output amplifiers
Audio amplifiers
Photodiode amplifiers
Datapath/mux/switch control

GENERAL DESCRIPTION

The [AD8646](#) and the [AD8647](#) are the dual, and the [AD8648](#) is the quad, rail-to-rail, input and output, single-supply amplifiers featuring low offset voltage, wide signal bandwidth, low input voltage, and low current noise. The [AD8647](#) also has a low power shutdown function.

The combination of 24 MHz bandwidth, low offset, low noise, and very low input bias current makes these amplifiers useful in a wide variety of applications. Filters, integrators, photodiode amplifiers, and high impedance sensors all benefit from the combination of performance features. AC applications benefit from the wide bandwidth and low distortion. The [AD8646/](#)

[AD8647/AD8648](#) offer high output drive capability, which is excellent for audio line drivers and other low impedance applications. The [AD8646](#) and [AD8648](#) are available for automotive applications (see the Ordering Guide).

Applications include portable and low powered instrumentation, audio amplification for portable devices, portable phone headsets, barcode scanners, and multipole filters. The ability to swing rail to rail at both the input and output enables designers to buffer CMOS ADCs, DACs, ASICs, and other wide output swing devices in single-supply systems.

PIN CONFIGURATIONS

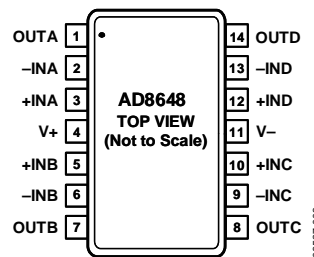
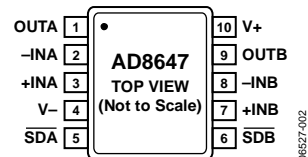
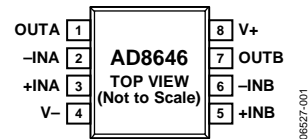

TABLE OF CONTENTS

| | |
|--------------------------------|---|
| Features | 1 |
| Applications | 1 |
| Pin Configurations | 1 |
| General Description | 1 |
| Revision History | 2 |
| Specifications | 3 |
| Absolute Maximum Ratings | 6 |
| Thermal Resistance | 6 |

REVISION HISTORY

3/14—Rev. D to Rev. E

| | |
|--|---|
| Changes to Differential Input Voltage, Table 3 | 6 |
|--|---|

4/10—Rev. C to Rev. D

| | |
|---|----|
| Changes to Features Section and General Description Section . | 1 |
| Updated Outline Dimensions | 16 |
| Changes to Ordering Guide Section | 18 |

Revision History: AD8646/AD8647/AD8648

2/09—Rev. B to Rev. C

| | |
|--|----|
| Change to Supply Current Shutdown Mode (AD8647 Only) Parameter, Table 1 | 3 |
| Change to Supply Current Shutdown Mode (AD8647 Only) Parameter, Table 2 | 5 |
| Added Figure 50; Renumbered Sequentially | 15 |
| Updated Outline Dimensions | 16 |
| Changes to Ordering Guide | 18 |

10/07—Revision B: Initial Combined Version

Revision History: AD8646

10/07—Rev. 0 to Rev. B

| | |
|-------------------------------------|-----------|
| Combined with AD8648 | Universal |
| Added AD8647 | Universal |
| Deleted Figure 4 and Figure 7 | 7 |
| Deleted Figure 33 | 11 |

8/07—Revision 0: Initial Version

| | |
|---|----|
| ESD Caution | 6 |
| Typical Performance Characteristics | 7 |
| Theory of Operation | 15 |
| Power-Down Operation | 15 |
| Multiplexing Operation | 15 |
| Outline Dimensions | 16 |
| Ordering Guide | 18 |

Revision History: AD8648

10/07—Rev. A to Rev. B

| | |
|--|-----------|
| Combined with AD8646 | Universal |
| Added AD8647 | Universal |
| Deleted Figure 7 | 6 |
| Deleted Figure 11 | 7 |
| Deleted Figure 16 and Figure 17 | 8 |
| Deleted Figure 24 | 9 |
| Deleted Figure 27, Figure 28, Figure 31, and Figure 32 | 10 |

6/07—Rev. 0 to Rev. A

| | |
|--------------------------------------|----|
| Changes to General Description | 1 |
| Updated Outline Dimensions | 12 |
| Changes to Ordering Guide | 12 |

1/06—Revision 0: Initial Version

SPECIFICATIONS

$V_{SY} = 5\text{ V}$, $V_{CM} = V_{SY}/2$, $T_A = +25^\circ\text{C}$, unless otherwise noted.

Table 1.

| Parameter | Symbol | Conditions | Min | Typ | Max | Unit | |
|---|--------------------------|--|------|-----------|------|------------------------------|----|
| INPUT CHARACTERISTICS | | | | | | | |
| Offset Voltage | V_{OS} | $V_{CM} = 0\text{ V to }5\text{ V}$ $-40^\circ\text{C} < T_A < +125^\circ\text{C}$ | | 0.6 | 2.5 | mV | |
| Offset Voltage Drift | $\Delta V_{OS}/\Delta T$ | $-40^\circ\text{C} < T_A < +125^\circ\text{C}$ | | 1.8 | 7.5 | $\mu\text{V}/^\circ\text{C}$ | |
| Input Bias Current | I_B | $-40^\circ\text{C} < T_A < +85^\circ\text{C}$ $-40^\circ\text{C} < T_A < +125^\circ\text{C}$ | | 0.3 | 1 | pA | |
| Input Offset Current | I_{OS} | $-40^\circ\text{C} < T_A < +85^\circ\text{C}$ | | | 50 | pA | |
| | | $-40^\circ\text{C} < T_A < +125^\circ\text{C}$ | | | 550 | pA | |
| | | $-40^\circ\text{C} < T_A < +85^\circ\text{C}$ $-40^\circ\text{C} < T_A < +125^\circ\text{C}$ | | 0.1 | 0.5 | pA | |
| Input Voltage Range | V_{CM} | | 0 | | 5 | V | |
| Common-Mode Rejection Ratio | CMRR | $V_{CM} = 0\text{ V to }5\text{ V}$ | 67 | 84 | | dB | |
| Large Signal Voltage Gain | A_{VO} | $R_L = 2\text{ k}\Omega$, $V_O = 0.5\text{ V to }4.5\text{ V}$ | 104 | 116 | | dB | |
| Input Capacitance | C_{DIFF} | | | | | pF | |
| Differential | | | | | | | |
| Common Mode | C_{CM} | | | | | 6.7 | pF |
| OUTPUT CHARACTERISTICS | | | | | | | |
| Output Voltage High | V_{OH} | $I_{OUT} = 1\text{ mA}$ $-40^\circ\text{C} < T_A < +125^\circ\text{C}$ | 4.98 | 4.99 | | V | |
| | | $I_{OUT} = 10\text{ mA}$ $-40^\circ\text{C} < T_A < +125^\circ\text{C}$ | 4.90 | | | V | |
| | | $I_{OUT} = 1\text{ mA}$ $-40^\circ\text{C} < T_A < +125^\circ\text{C}$ | 4.85 | 4.92 | | V | |
| | | $I_{OUT} = 10\text{ mA}$ $-40^\circ\text{C} < T_A < +125^\circ\text{C}$ | 4.70 | | | V | |
| Output Voltage Low | V_{OL} | $I_{OUT} = 1\text{ mA}$ $-40^\circ\text{C} < T_A < +125^\circ\text{C}$ | | 8.4 | 20 | mV | |
| | | $I_{OUT} = 10\text{ mA}$ $-40^\circ\text{C} < T_A < +125^\circ\text{C}$ | | | 40 | mV | |
| | | $I_{OUT} = 1\text{ mA}$ $-40^\circ\text{C} < T_A < +125^\circ\text{C}$ | | 78 | 145 | mV | |
| | | $I_{OUT} = 10\text{ mA}$ $-40^\circ\text{C} < T_A < +125^\circ\text{C}$ | | | 200 | mV | |
| Output Current | I_{SC} | Short circuit | | ± 120 | | mA | |
| Closed-Loop Output Impedance | Z_{OUT} | At 1 MHz, $A_V = 1$ | | 5 | | Ω | |
| POWER SUPPLY | | | | | | | |
| Power Supply Rejection Ratio | PSRR | $V_{SY} = 2.7\text{ V to }5.5\text{ V}$ | 63 | 80 | | dB | |
| Supply Current per Amplifier | I_{SY} | $-40^\circ\text{C} < T_A < +125^\circ\text{C}$ | | 1.5 | 2.0 | mA | |
| | | $-40^\circ\text{C} < T_A < +125^\circ\text{C}$ | | | 2.5 | mA | |
| Supply Current Shutdown Mode (AD8647 Only) | I_{SD} | Both amplifiers shut down, V_{IN_SDA} and $V_{IN_SDB} = 0\text{ V}$ $-40^\circ\text{C} < T_A < +125^\circ\text{C}$ | | 10 | | nA | |
| | | | | | 1 | μA | |
| SHUTDOWN INPUTS (AD8647) | | | | | | | |
| Logic High Voltage (Enabled) | V_{INH} | $-40^\circ\text{C} < T_A < +125^\circ\text{C}$ | +2.0 | | | V | |
| Logic Low Voltage (Power-Down) | V_{INL} | $-40^\circ\text{C} < T_A < +125^\circ\text{C}$ | | | +0.8 | V | |
| Logic Input Current (Per Pin) | I_{IN} | $-40^\circ\text{C} < T_A < +125^\circ\text{C}$ | | | 1 | μA | |
| Output Pin Leakage Current | | $-40^\circ\text{C} < T_A < +125^\circ\text{C}$ (shutdown active) | | 1 | | nA | |
| DYNAMIC PERFORMANCE | | | | | | | |
| Slew Rate | SR | $R_L = 2\text{ k}\Omega$ | | 11 | | V/ μs | |
| Gain Bandwidth Product | GBP | | | 24 | | MHz | |
| Phase Margin | ϕ_m | | | 74 | | Degrees | |
| Settling Time | t_s | To 0.1% | | 0.5 | | μs | |
| Amplifier Turn-On Time (AD8647) | t_{on} | 25°C , $A_V = 1$, $R_L = 1\text{ k}\Omega$ (see Figure 44) | | 1 | | μs | |
| Amplifier Turn-Off Time (AD8647) | t_{off} | 25°C , $A_V = 1$, $R_L = 1\text{ k}\Omega$ (see Figure 45) | | 1 | | μs | |

| Parameter | Symbol | Conditions | Min | Typ | Max | Unit |
|--------------------------------------|-----------|---|-----|-------|-----|------------------------------|
| NOISE PERFORMANCE | | | | | | |
| Peak-to-Peak Noise | e_n p-p | 0.1 Hz to 10 Hz | | 2.3 | | μV |
| Voltage Noise Density | e_n | $f = 1 \text{ kHz}$ | | 8 | | $\text{nV}/\sqrt{\text{Hz}}$ |
| | | $f = 10 \text{ kHz}$ | | 6 | | $\text{nV}/\sqrt{\text{Hz}}$ |
| Channel Separation | CS | $f = 10 \text{ kHz}$ | | -115 | | dB |
| | | $f = 100 \text{ kHz}$ | | -110 | | dB |
| Total Harmonic Distortion Plus Noise | THD + N | $V_{p-p} = 0.1 \text{ V}, R_L = 600 \Omega, f = 25 \text{ kHz}, T_A = 25^\circ\text{C}$ | | | | |
| | | $A_V = +1$ | | 0.010 | | % |
| | | $A_V = -10$ | | 0.021 | | % |

$V_{SY} = 2.7\text{ V}$, $V_{CM} = V_{SY}/2$, $T_A = +25^\circ\text{C}$, unless otherwise noted.

Table 2.

| Parameter | Symbol | Conditions | Min | Typ | Max | Unit |
|---|--------------------------|--|------|----------|------|--|
| INPUT CHARACTERISTICS | | | | | | |
| Offset Voltage | V_{OS} | $V_{CM} = 0\text{ V to } 2.7\text{ V}$ $-40^\circ\text{C} < T_A < +125^\circ\text{C}$ | | 0.6 | 2.5 | mV |
| Offset Voltage Drift | $\Delta V_{OS}/\Delta T$ | $-40^\circ\text{C} < T_A < +125^\circ\text{C}$ | | 1.8 | 7.0 | $\mu\text{V}/^\circ\text{C}$ |
| Input Bias Current | I_B | $-40^\circ\text{C} < T_A < +85^\circ\text{C}$ $-40^\circ\text{C} < T_A < +125^\circ\text{C}$ | | 0.2 | 1 | pA |
| Input Offset Current | I_{OS} | $-40^\circ\text{C} < T_A < +85^\circ\text{C}$ $-40^\circ\text{C} < T_A < +125^\circ\text{C}$ | | 0.1 | 0.5 | pA |
| Input Voltage Range | V_{CM} | | 0 | | 2.7 | V |
| Common-Mode Rejection Ratio | CMRR | $V_{CM} = 0\text{ V to } 2.7\text{ V}$ | 62 | 79 | | dB |
| Large Signal Voltage Gain | A_{VO} | $R_L = 2\text{ k}\Omega$, $V_O = 0.5\text{ V to } 2.2\text{ V}$ | 95 | 102 | | dB |
| Input Capacitance | | | | | | |
| Differential | C_{DIFF} | | | 2.5 | | pF |
| Common Mode | C_{CM} | | | 7.8 | | pF |
| OUTPUT CHARACTERISTICS | | | | | | |
| Output Voltage High | V_{OH} | $I_{OUT} = 1\text{ mA}$ $-40^\circ\text{C} < T_A < +125^\circ\text{C}$ | 2.65 | 2.68 | | V |
| Output Voltage Low | V_{OL} | $I_{OUT} = 1\text{ mA}$ $-40^\circ\text{C} < T_A < +125^\circ\text{C}$ | 2.60 | 11 | 25 | V |
| Output Current | I_{SC} | Short circuit | | ± 63 | 30 | mV |
| Closed-Loop Output Impedance | Z_{OUT} | At 1 MHz, $A_V = 1$ | | 5 | | Ω |
| POWER SUPPLY | | | | | | |
| Power Supply Rejection Ratio | PSRR | $V_{SY} = 2.7\text{ V to } 5.5\text{ V}$ | 63 | 80 | | dB |
| Supply Current per Amplifier | I_{SY} | $-40^\circ\text{C} < T_A < +125^\circ\text{C}$ | | 1.6 | 2.0 | mA |
| Supply Current Shutdown Mode (AD8647 Only) | I_{SD} | Both amplifiers shut down, V_{IN_SDA} and $V_{IN_SDB} = 0\text{ V}$ $-40^\circ\text{C} < T_A < +125^\circ\text{C}$ | | 10 | 2.5 | mA |
| | | | | | 1 | μA |
| SHUTDOWN INPUTS (AD8647) | | | | | | |
| Logic High Voltage (Enabled) | V_{INH} | $-40^\circ\text{C} < T_A < +125^\circ\text{C}$ | +2.0 | | | V |
| Logic Low Voltage (Power-Down) | V_{INL} | $-40^\circ\text{C} < T_A < +125^\circ\text{C}$ | | | +0.8 | V |
| Logic Input Current (Per Pin) | I_{IN} | $-40^\circ\text{C} < T_A < +125^\circ\text{C}$ | | | 1 | μA |
| Output Pin Leakage Current | | $-40^\circ\text{C} < T_A < +125^\circ\text{C}$ (shutdown active) | | 1 | | nA |
| DYNAMIC PERFORMANCE | | | | | | |
| Slew Rate | SR | $R_L = 2\text{ k}\Omega$ | | 11 | | V/ μs |
| Gain Bandwidth Product | GBP | | | 24 | | MHz |
| Phase Margin | ϕ_m | | | 53 | | Degrees |
| Settling Time | t_s | To 0.1% | | 0.3 | | μs |
| Amplifier Turn-On Time (AD8647) | t_{on} | 25°C , $A_V = 1$, $R_L = 1\text{ k}\Omega$ (see Figure 41) | | 1.2 | | μs |
| Amplifier Turn-Off Time (AD8647) | t_{off} | 25°C , $A_V = 1$, $R_L = 1\text{ k}\Omega$ (see Figure 42) | | 1 | | μs |
| NOISE PERFORMANCE | | | | | | |
| Peak-to-Peak Noise | e_n p-p | 0.1 Hz to 10 Hz | | 2.3 | | μV |
| Voltage Noise Density | e_n | $f = 1\text{ kHz}$ $f = 10\text{ kHz}$ | | 8 | 6 | $\text{nV}/\sqrt{\text{Hz}}$ $\text{nV}/\sqrt{\text{Hz}}$ |
| Channel Separation | CS | $f = 10\text{ kHz}$ $f = 100\text{ kHz}$ | | -115 | -110 | dB dB |

ABSOLUTE MAXIMUM RATINGS

Table 3.

| Parameter | Rating |
|-------------------------------------|---|
| Supply Voltage | 6 V |
| Input Voltage | GND to V_{SY} |
| Differential Input Voltage | ± 6 V |
| Output Short Circuit to GND | Indefinite |
| Storage Temperature Range | -65°C to $+150^{\circ}\text{C}$ |
| Operating Temperature Range | -40°C to $+125^{\circ}\text{C}$ |
| Lead Temperature (Soldering 60 sec) | 300°C |
| Junction Temperature | 150°C |

Stresses above those listed under Absolute Maximum Ratings may cause permanent damage to the device. This is a stress rating only; functional operation of the device at these or any other conditions above those indicated in the operational section of this specification is not implied. Exposure to absolute maximum rating conditions for extended periods may affect device reliability.

THERMAL RESISTANCE

θ_{JA} is specified for the worst-case conditions, that is, a device soldered in a circuit board for surface-mount packages.

Table 4. Thermal Resistance

| Package Type | θ_{JA} | θ_{JC} | Unit |
|----------------|---------------|---------------|-----------------------------|
| 8-Lead SOIC_N | 125 | 43 | $^{\circ}\text{C}/\text{W}$ |
| 8-Lead MSOP | 210 | 45 | $^{\circ}\text{C}/\text{W}$ |
| 10-Lead MSOP | 200 | 44 | $^{\circ}\text{C}/\text{W}$ |
| 14-Lead SOIC_N | 120 | 36 | $^{\circ}\text{C}/\text{W}$ |
| 14-Lead TSSOP | 180 | 35 | $^{\circ}\text{C}/\text{W}$ |

ESD CAUTION



ESD (electrostatic discharge) sensitive device. Charged devices and circuit boards can discharge without detection. Although this product features patented or proprietary protection circuitry, damage may occur on devices subjected to high energy ESD. Therefore, proper ESD precautions should be taken to avoid performance degradation or loss of functionality.

TYPICAL PERFORMANCE CHARACTERISTICS

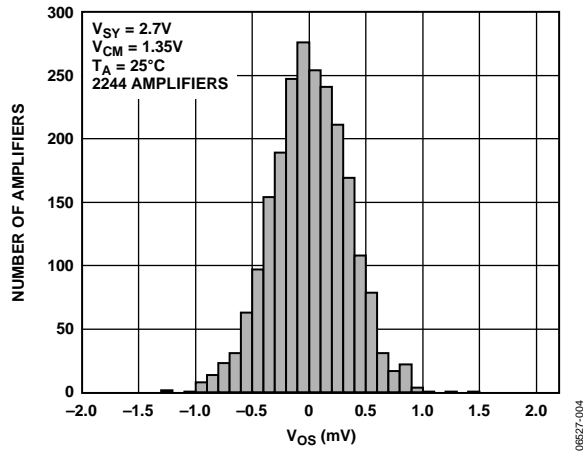

Figure 4. Input Offset Voltage Distribution

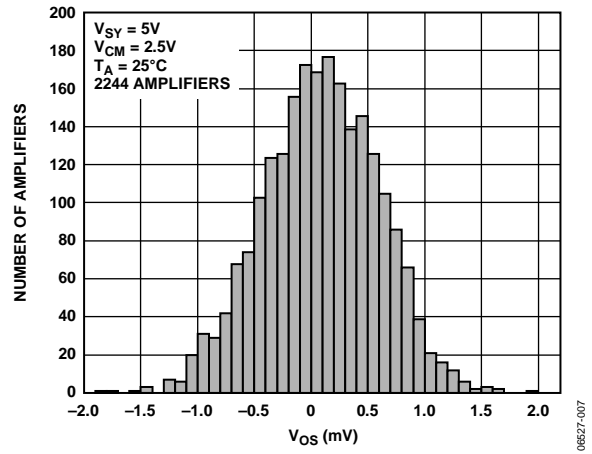

Figure 7. Input Offset Voltage Distribution

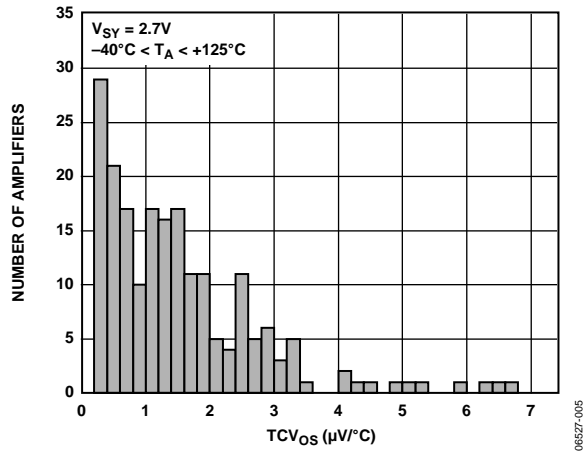

Figure 5. V_{OS} Drift (TCV_{OS}) Distribution

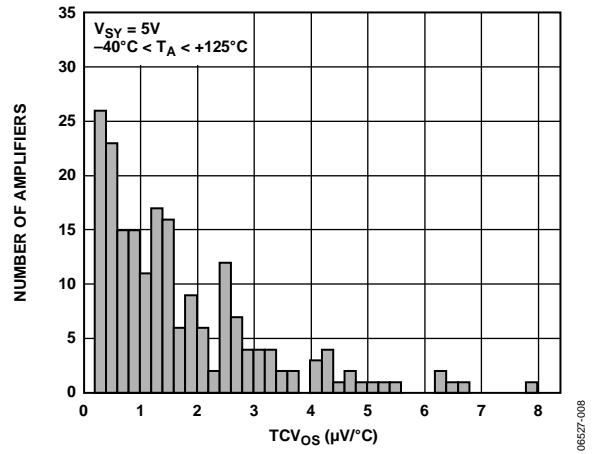

Figure 8. V_{OS} Drift (TCV_{OS}) Distribution

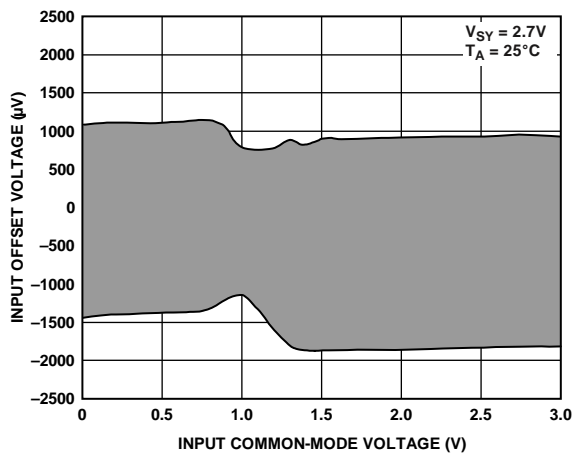

Figure 6. Input Offset Voltage vs. Input Common-Mode Voltage

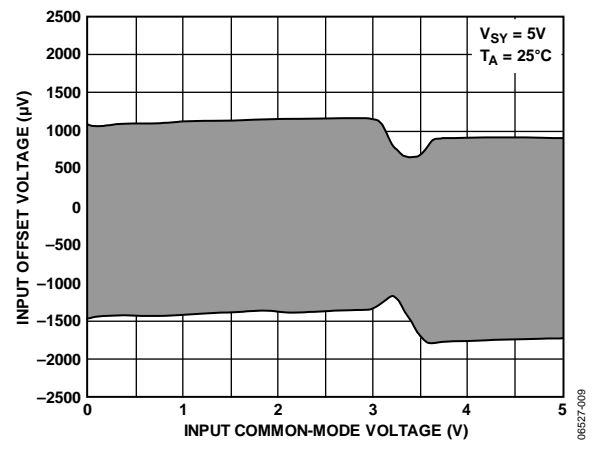

Figure 9. Input Offset Voltage vs. Input Common-Mode Voltage

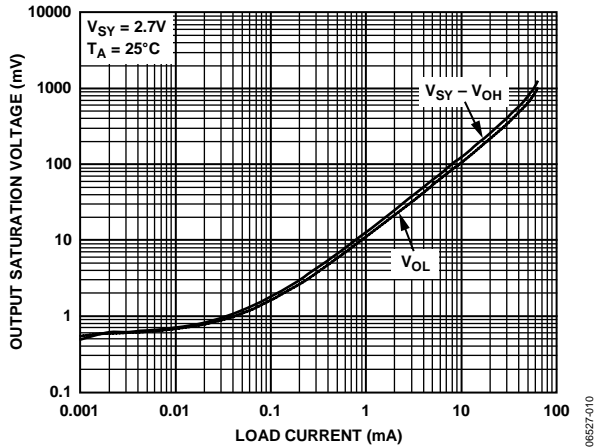

Figure 10. Output Saturation Voltage vs. Load Current

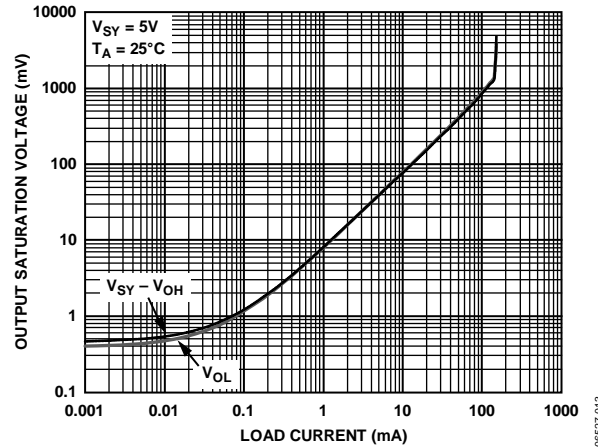

Figure 13. Output Saturation Voltage vs. Load Current

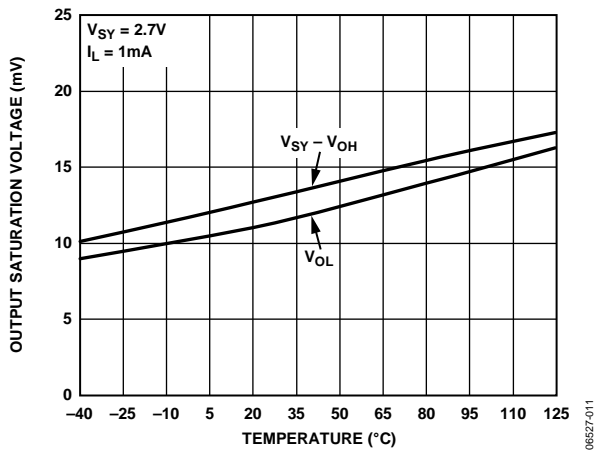

Figure 11. Output Saturation Voltage vs. Temperature

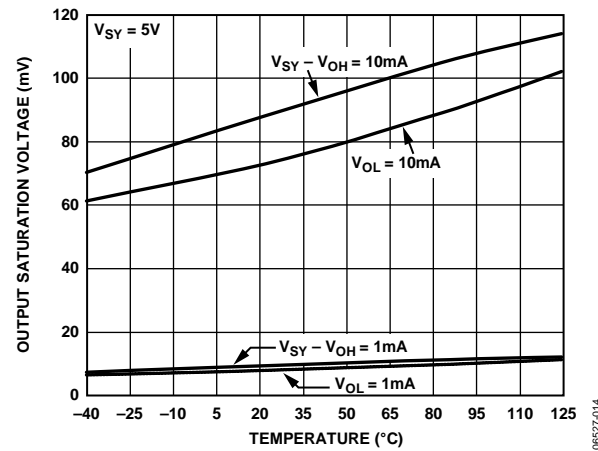

Figure 14. Output Saturation Voltage vs. Temperature

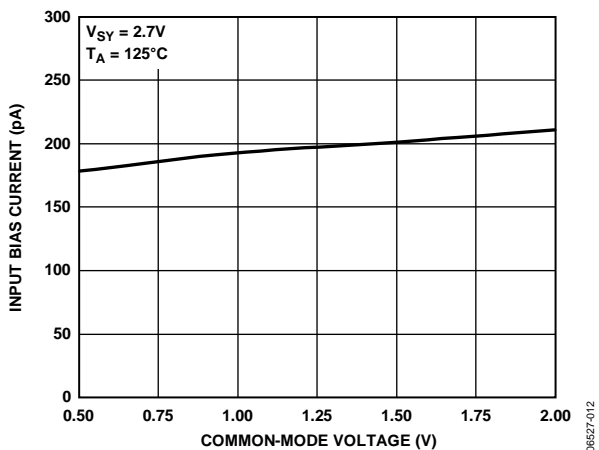

Figure 12. Input Bias Current vs. Common-Mode Voltage

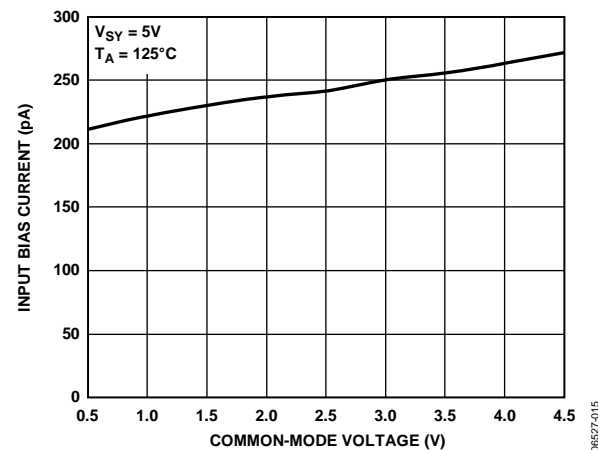

Figure 15. Input Bias Current vs. Common-Mode Voltage

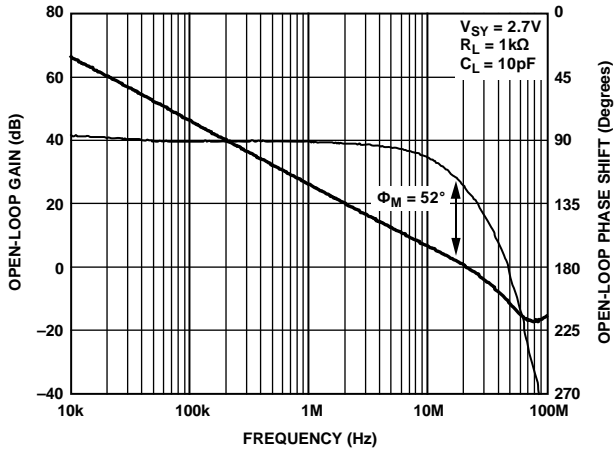

Figure 16. Open-Loop Gain and Phase vs. Frequency

06527-016

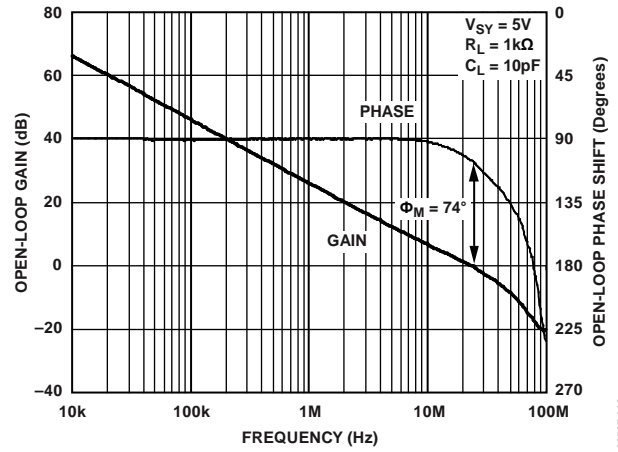

Figure 19. Open-Loop Gain and Phase vs. Frequency

06527-019

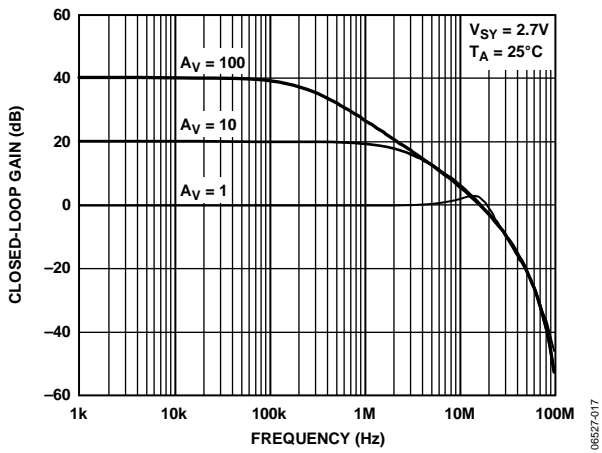

Figure 17. Closed-Loop Gain vs. Frequency

06527-017

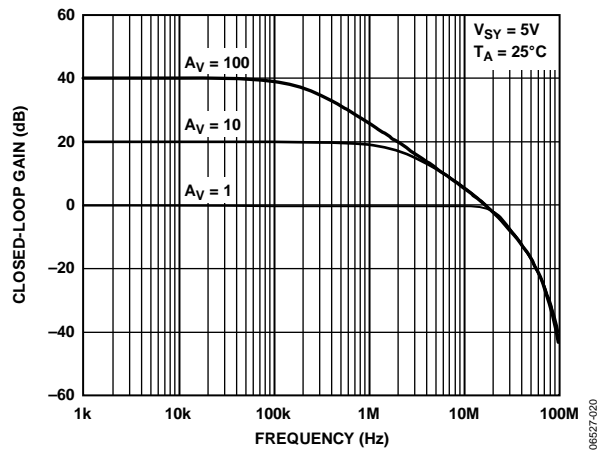

Figure 20. Closed-Loop Gain vs. Frequency

06527-020

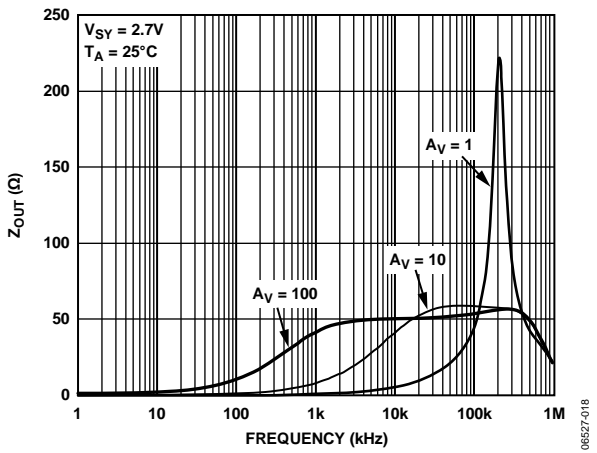

Figure 18. Z_{OUT} vs. Frequency

06527-018

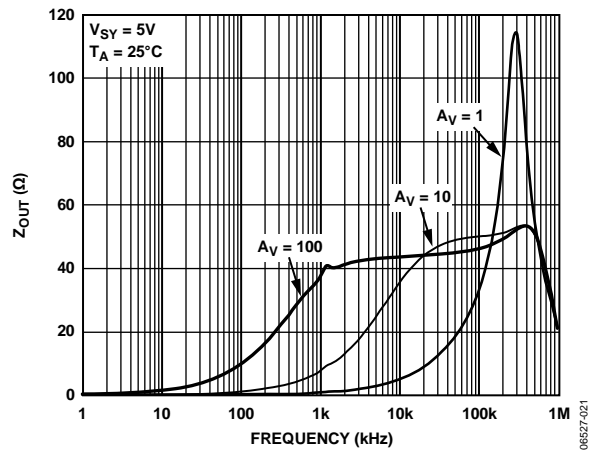

Figure 21. Z_{OUT} vs. Frequency

06527-021

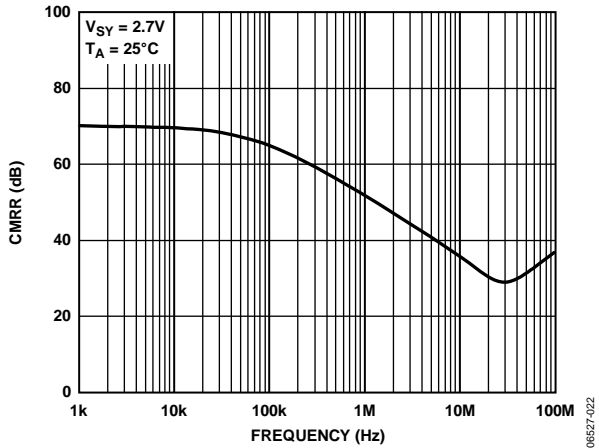

Figure 22. CMRR vs. Frequency

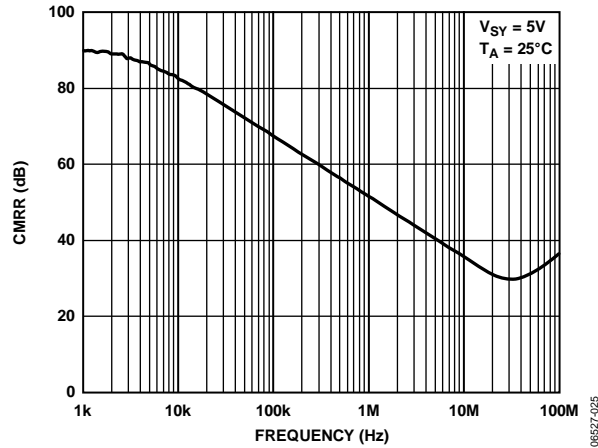

Figure 25. CMRR vs. Frequency

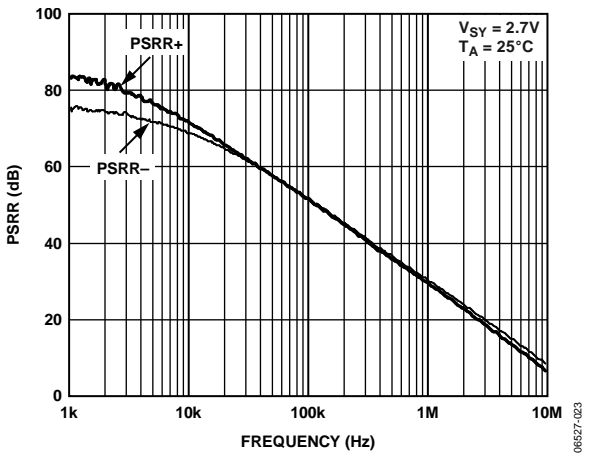

Figure 23. PSRR vs. Frequency

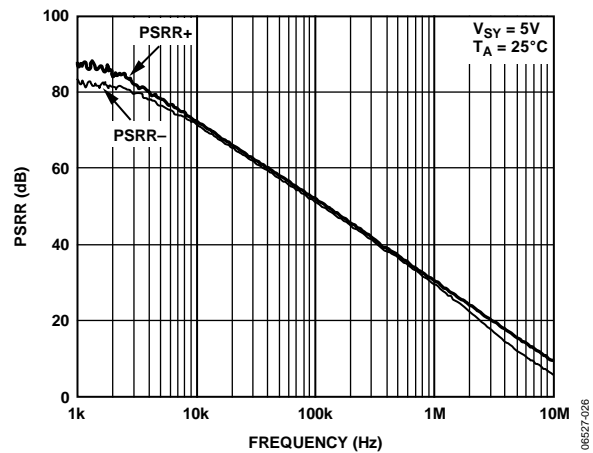

Figure 26. PSRR vs. Frequency

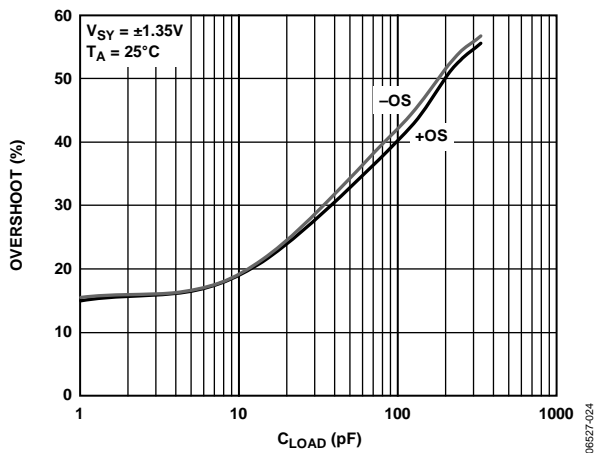

Figure 24. Overshoot vs. Load Capacitance

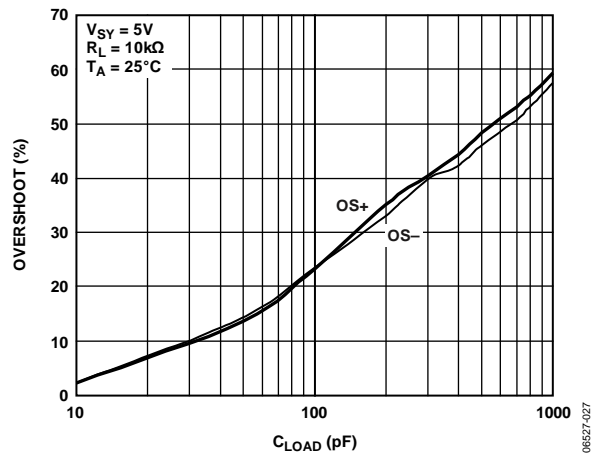

Figure 27. Overshoot vs. Load Capacitance

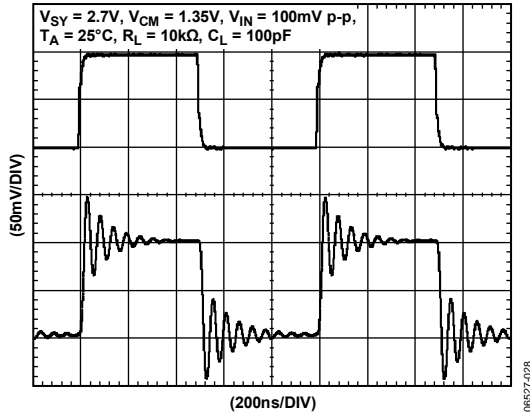

Figure 28. Small-Signal Transient Response

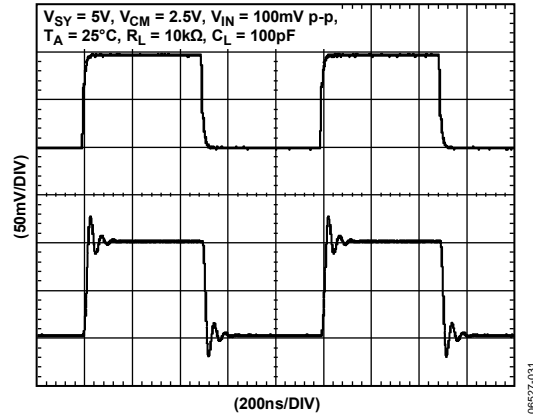

Figure 31. Small-Signal Transient Response

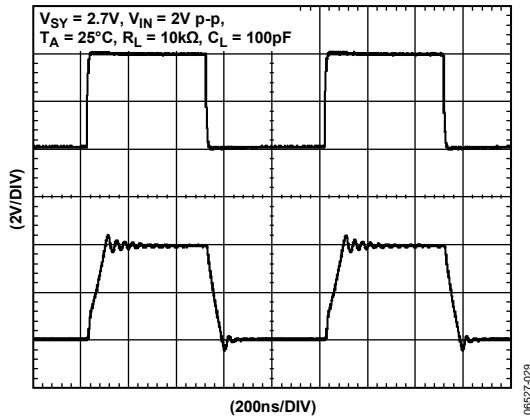

Figure 29. Large-Signal Transient Response

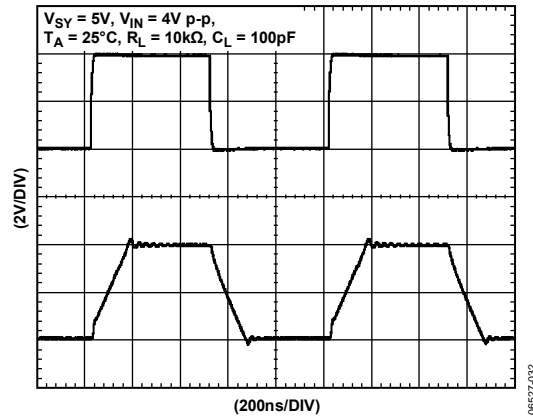

Figure 32. Large-Signal Transient Response

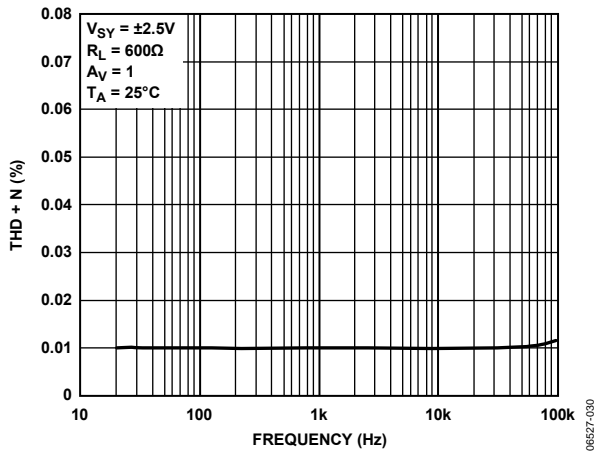

Figure 30. THD + Noise vs. Frequency

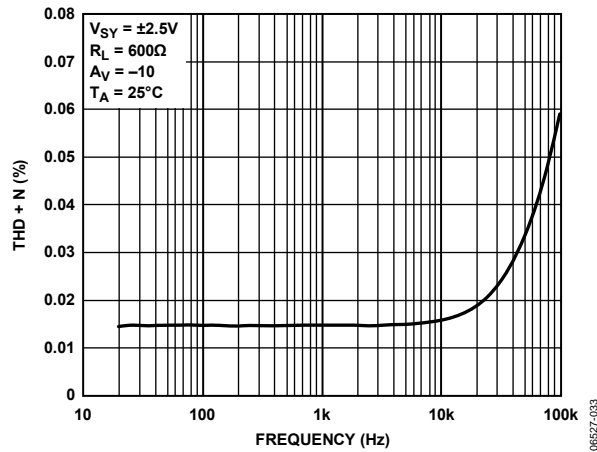

Figure 33. THD + Noise vs. Frequency

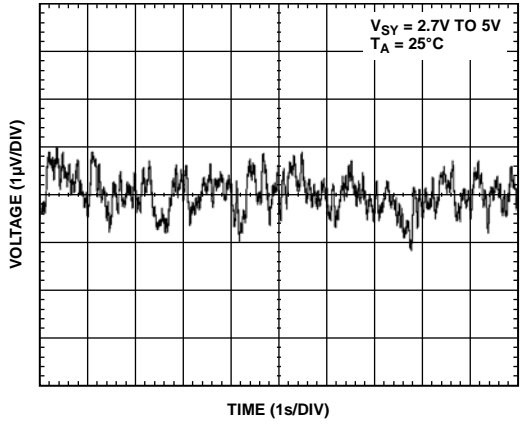

Figure 34. 0.1 Hz to 10 Hz Voltage Noise

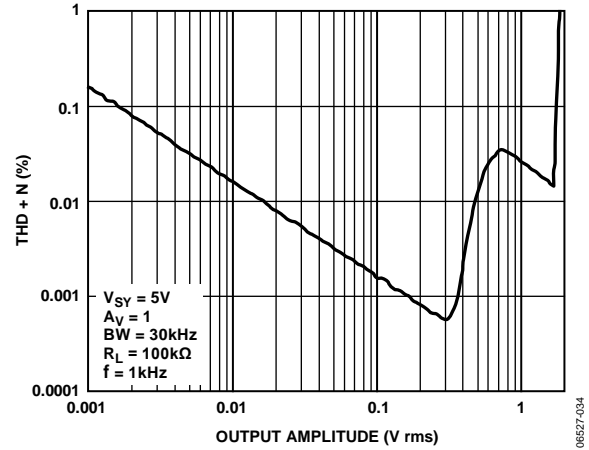

Figure 37. THD + Noise vs. Output Amplitude

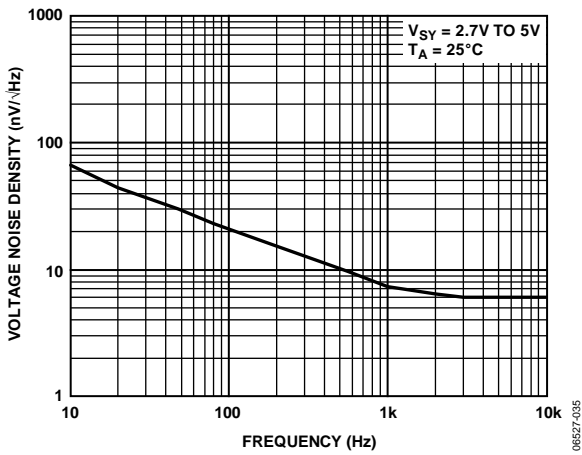

Figure 35. Voltage Noise Density vs. Frequency

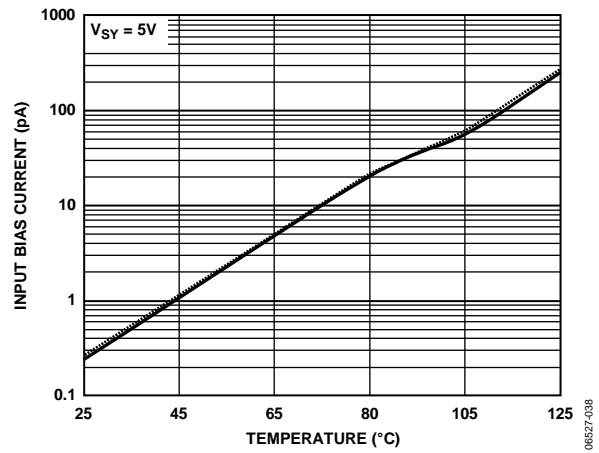

Figure 38. Input Bias Current vs. Temperature

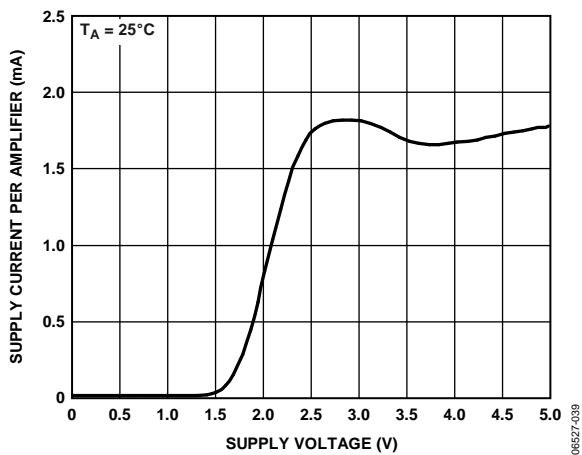

Figure 36. Supply Current per Amplifier vs. Supply Voltage

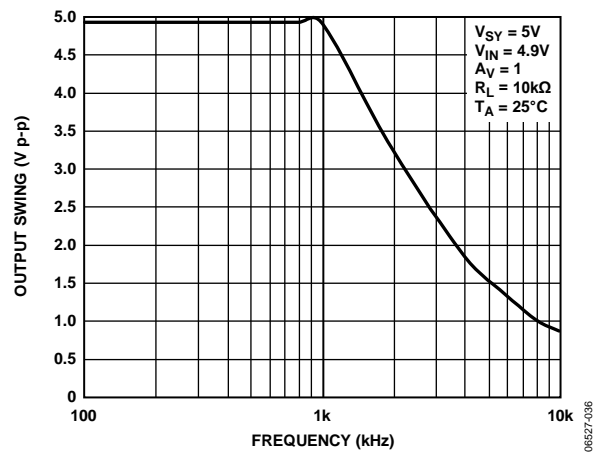

Figure 39. Maximum Output Swing vs. Frequency

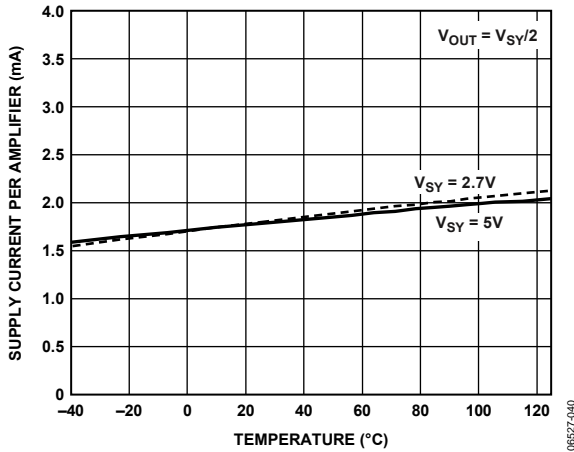

Figure 40. Supply Current per Amplifier vs. Temperature

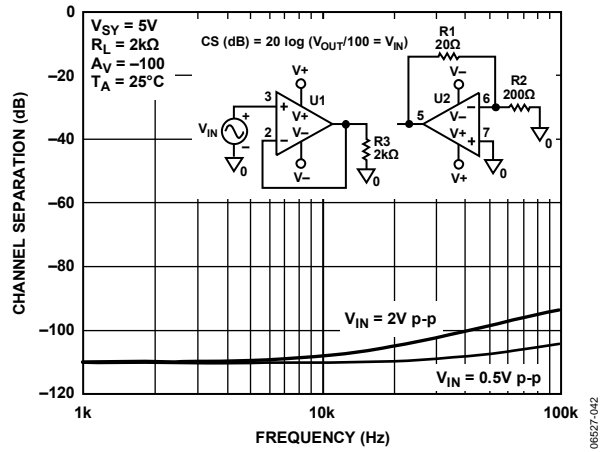

Figure 43. Channel Separation

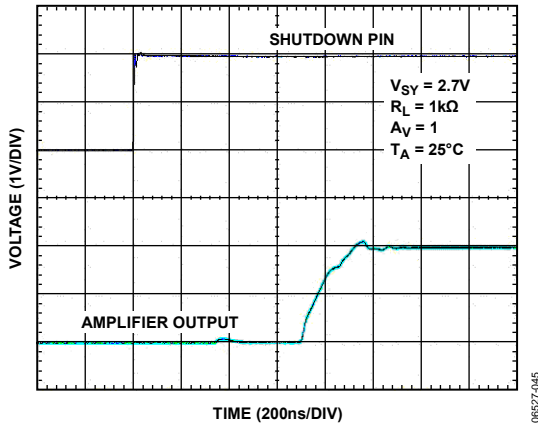

Figure 41. Turn-On Time

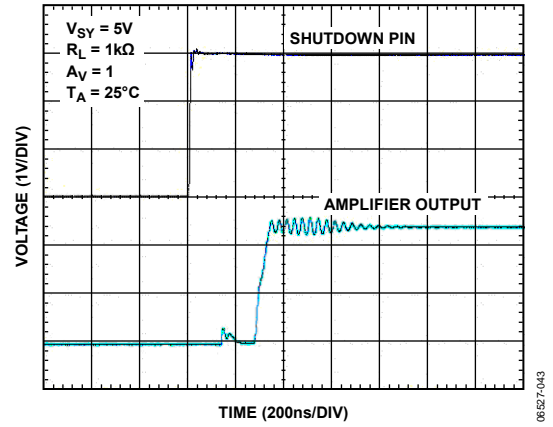

Figure 44. Turn-On Time

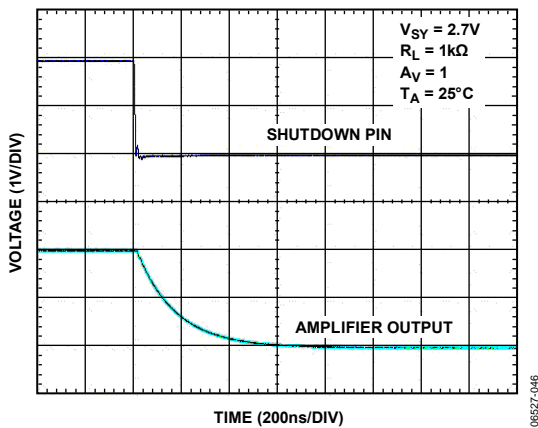

Figure 42. Turn-Off Time

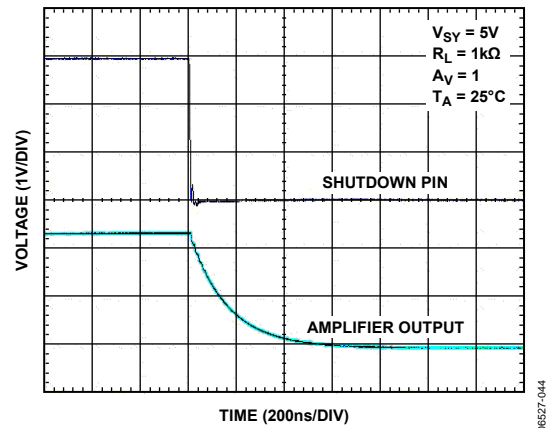

Figure 45. Turn-Off Time

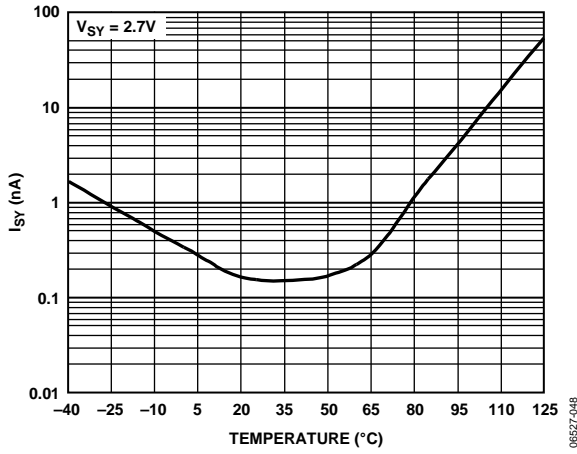

Figure 46. Supply Current with Op-Amp Shutdown vs. Temperature

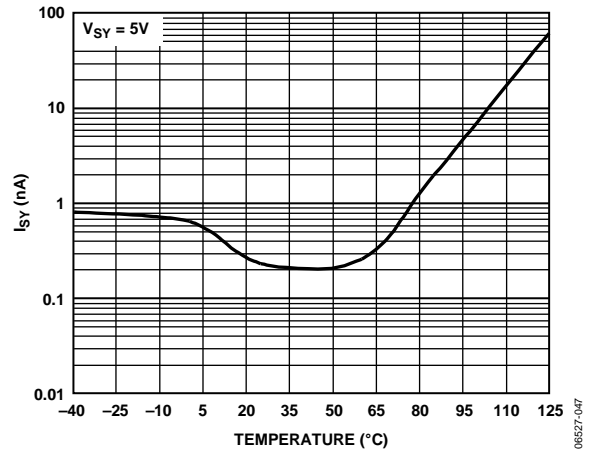

Figure 47. Supply Current with Op-Amp Shutdown vs. Temperature

THEORY OF OPERATION

POWER-DOWN OPERATION

The shutdown function of the AD8647 is referenced to the negative supply voltage of the operational amplifier. A logic level high ($> 2.0\text{ V}$) enables the device, while a logic level low ($< 0.8\text{ V}$) disables the device and places the output in a high impedance condition. Several outputs can be wire-ORed, thus eliminating a multiplexer. The logic input is a high impedance CMOS input. If dual or split supplies are used, the logic signals must be properly referred to the negative supply voltage.

MULTIPLEXING OPERATION

Because each op amp has a separate logic input enable pin, the outputs can be connected together if it can be guaranteed that only one op amp is active at any time. By connecting the op amps as shown in Figure 48, a multiplexer can be eliminated. With the reasonably short turn-on and turn-off times, low frequency signal paths can be smoothly selected. The turn-off time is slightly faster than the turn-on time so, even when using sections from two different packages, the overlap is less than 300 nanoseconds.

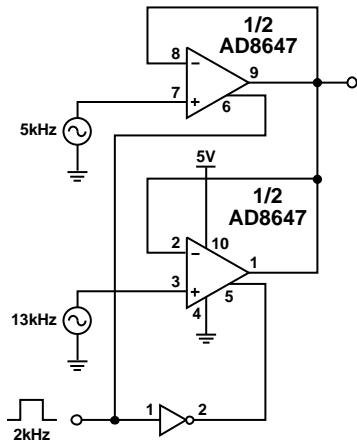

Figure 48. AD8647 Output Switching

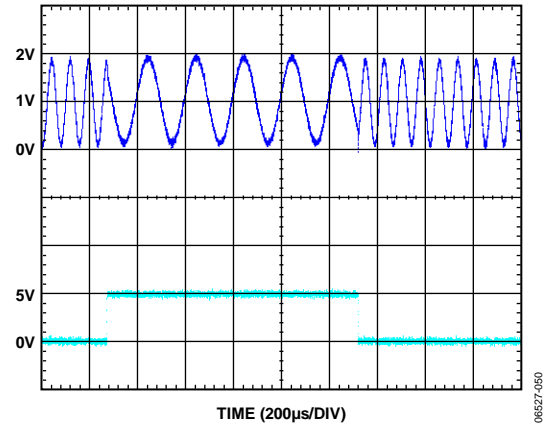

Figure 49. Switching Waveforms

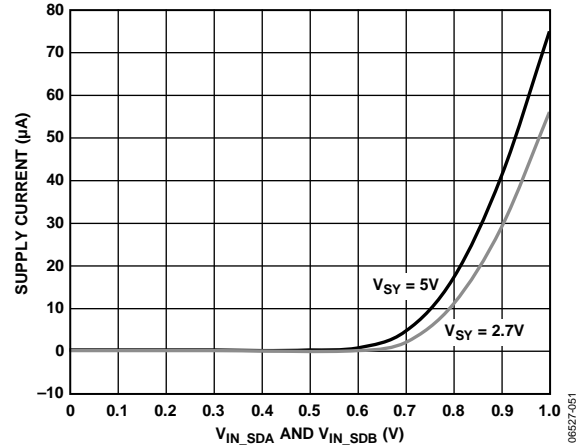
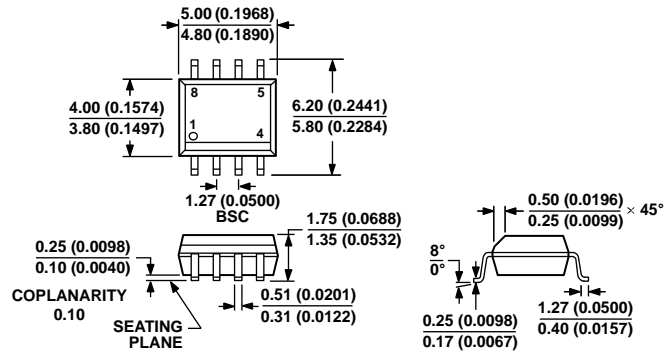

Figure 50. Supply Current Shutdown Mode, AD8647

OUTLINE DIMENSIONS



COMPLIANT TO JEDEC STANDARDS MS-012-AA
 CONTROLLING DIMENSIONS ARE IN MILLIMETERS; INCH DIMENSIONS
 (IN PARENTHESES) ARE ROUNDED-OFF MILLIMETER EQUIVALENTS FOR
 REFERENCE ONLY AND ARE NOT APPROPRIATE FOR USE IN DESIGN.

Figure 51. 8-Lead Standard Small Outline Package [SOIC_N]
 Narrow Body
 (R-8)

Dimensions shown in millimeters and (inches)

012407-A

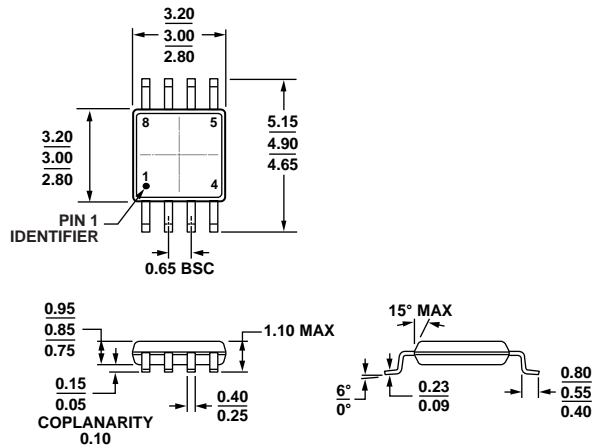

COMPLIANT TO JEDEC STANDARDS MO-187-AA
 Figure 52. 8-Lead Mini Small Outline Package [MSOP]
 (RM-8)

Dimensions shown in millimeters

100709-B

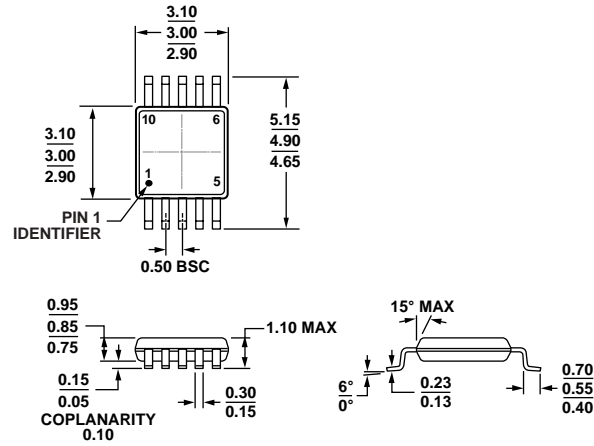

COMPLIANT TO JEDEC STANDARDS MO-187-BA

Figure 53. 10-Lead Mini Small Outline Package [MSOP] (RM-10)

Dimensions shown in millimeters

001708-A

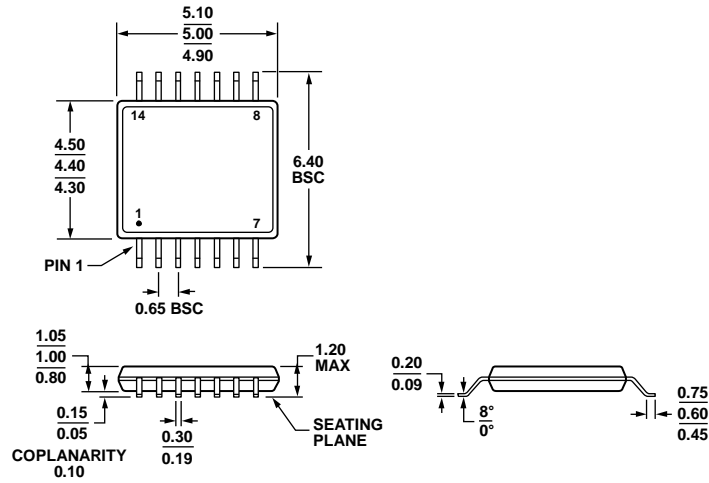

COMPLIANT TO JEDEC STANDARDS MO-153-AB-1

Figure 54. 14-Lead Thin Shrink Small Outline Package [TSSOP] (RU-14)

Dimensions shown in millimeters

061988-A

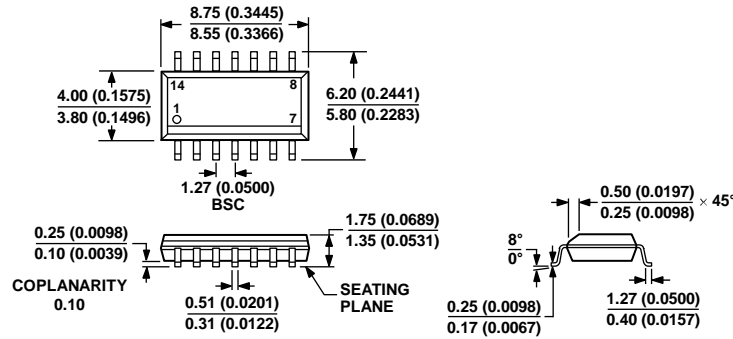

COMPLIANT TO JEDEC STANDARDS MS-012-AB
 CONTROLLING DIMENSIONS ARE IN MILLIMETERS; INCH DIMENSIONS
 (IN PARENTHESES) ARE ROUNDED-OFF MILLIMETER EQUIVALENTS FOR
 REFERENCE ONLY AND ARE NOT APPROPRIATE FOR USE IN DESIGN.

060606-A

Figure 55. 14-Lead Standard Small Outline Package [SOIC_N]
 Narrow Body
 (R-14)

Dimensions shown in millimeters and (inches)

ORDERING GUIDE

| Model ^{1, 2} | Temperature Range | Package Description | Package Option | Branding |
|-----------------------|-------------------|---------------------|----------------|----------|
| AD8646ARZ | -40°C to +125°C | 8-Lead SOIC_N | R-8 | |
| AD8646ARZ-REEL | -40°C to +125°C | 8-Lead SOIC_N | R-8 | |
| AD8646ARZ-REEL7 | -40°C to +125°C | 8-Lead SOIC_N | R-8 | |
| AD8646ARMZ | -40°C to +125°C | 8-Lead MSOP | RM-8 | A1V |
| AD8646ARMZ-REEL | -40°C to +125°C | 8-Lead MSOP | RM-8 | A1V |
| AD8646WARZ-RL | -40°C to +125°C | 8-Lead SOIC_N | R-8 | |
| AD8646WARZ-R7 | -40°C to +125°C | 8-Lead SOIC_N | R-8 | |
| AD8646WARMZ-RL | -40°C to +125°C | 8-Lead MSOP | RM-8 | A1V |
| AD8646WARMZ-R7 | -40°C to +125°C | 8-Lead MSOP | RM-8 | A1V |
| AD8647ARMZ | -40°C to +125°C | 10-Lead MSOP | RM-10 | A1W |
| AD8647ARMZ-REEL | -40°C to +125°C | 10-Lead MSOP | RM-10 | A1W |
| AD8648ARZ | -40°C to +125°C | 14-Lead SOIC_N | R-14 | |
| AD8648ARZ-REEL | -40°C to +125°C | 14-Lead SOIC_N | R-14 | |
| AD8648ARZ-REEL7 | -40°C to +125°C | 14-Lead SOIC_N | R-14 | |
| AD8648ARUZ | -40°C to +125°C | 14-Lead TSSOP | RU-14 | |
| AD8648ARUZ-REEL | -40°C to +125°C | 14-Lead TSSOP | RU-14 | |
| AD8648WARUZ | -40°C to +125°C | 14-Lead TSSOP | RU-14 | |
| AD8648WARUZ-RL | -40°C to +125°C | 14-Lead TSSOP | RU-14 | |

¹ Z = RoHS Compliant Part.
² W = Qualified for Automotive Applications.

NOTES

NOTES