

# Optocoupler, Phototransistor Output, with Base Connection

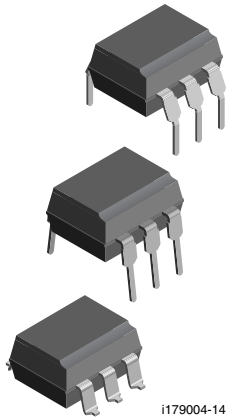

i179004-14

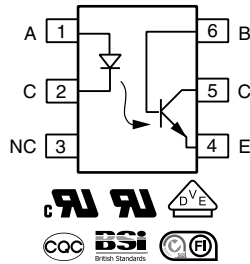

## FEATURES

- Isolation test voltage: 5000 V<sub>RMS</sub>
- Long term stability
- Industry standard dual-in-line package
- Material categorization:  
For definitions of compliance please see [www.vishay.com/doc?99912](http://www.vishay.com/doc?99912)

**RoHS**  
COMPLIANT

## AGENCY APPROVALS

Safety application model number covering all products in this datasheet is CNY17. This model number should be used when consulting safety agency documents.

- UL file no. E52744
- cUL tested to CSA 22.2 bulletin 5A
- DIN EN 60747-5-5 (VDE 0884-5)
- BSI IEC 60950, IEC 60065
- FIMKO EN60950
- CQC GB8898-2011

## DESCRIPTION

The CNY17 is an optically coupled pair consisting of a gallium arsenide infrared emitting diode optically coupled to a silicon NPN phototransistor.

Signal information, including a DC level, can be transmitted by the device while maintaining a high degree of electrical isolation between input and output.

The CNY17 can be used to replace relays and transformers in many digital interface applications, as well as analog applications such as CRT modulation.

| ORDERING INFORMATION   |                             |                             |                             |                             |   |   |   |   |   |   |   |   |  |  |  |  |
|--|-----------------------------|-----------------------------|-----------------------------|-----------------------------|---|---|---|---|---|---|---|---|--|--|--|--|
| <table border="1" style="margin-left: auto; margin-right: auto;"> <tr> <td style="padding: 5px;">C</td> <td style="padding: 5px;">N</td> <td style="padding: 5px;">Y</td> <td style="padding: 5px;">1</td> <td style="padding: 5px;">7</td> <td style="padding: 5px;">-</td> <td style="padding: 5px;">#</td> <td style="padding: 5px;">X</td> <td style="padding: 5px;">0</td> <td style="padding: 5px;">#</td> <td style="padding: 5px;">#</td> <td style="padding: 5px;">T</td> </tr> </table> <p style="text-align: center;">PART NUMBER</p> <p style="text-align: center;">CTR BIN</p> <p style="text-align: center;">PACKAGE OPTION</p> <p style="text-align: center;">TAPE AND REEL</p> | C                           | N                           | Y                           | 1                           | 7 | - | # | X | 0 | # | # | T |  |  |  |  |
| C  | N                           | Y                           | 1                           | 7                           | - | # | X | 0 | # | # | T |   |  |  |  |  |
| AGENCY CERTIFIED/PACKAGE   | CTR (%)                     |                             |                             |                             |   |   |   |   |   |   |   |   |  |  |  |  |
| <b>UL, cUL, BSI, FIMKO</b>   | <b>40 to 80</b>             | <b>63 to 125</b>            | <b>100 to 200</b>           | <b>160 to 320</b>           |   |   |   |   |   |   |   |   |  |  |  |  |
| DIP-6  | CNY17-1                     | CNY17-2                     | CNY17-3                     | CNY17-4                     |   |   |   |   |   |   |   |   |  |  |  |  |
| DIP-6, 400 mil, option 6   | CNY17-1X006                 | CNY17-2X006                 | CNY17-3X006                 | CNY17-4X006                 |   |   |   |   |   |   |   |   |  |  |  |  |
| SMD-6, option 7  | CNY17-1X007T <sup>(1)</sup> | CNY17-2X007T <sup>(1)</sup> | CNY17-3X007T <sup>(1)</sup> | CNY17-4X007T <sup>(1)</sup> |   |   |   |   |   |   |   |   |  |  |  |  |
| SMD-6, option 9  | CNY17-1X009T <sup>(1)</sup> | CNY17-2X009T <sup>(1)</sup> | CNY17-3X009T <sup>(1)</sup> | CNY17-4X009T <sup>(1)</sup> |   |   |   |   |   |   |   |   |  |  |  |  |
| <b>VDE, UL, cUL, BSI, FIMKO</b>  | <b>40 to 80</b>             | <b>63 to 125</b>            | <b>100 to 200</b>           | <b>160 to 320</b>           |   |   |   |   |   |   |   |   |  |  |  |  |
| DIP-6  | CNY17-1X001                 | CNY17-2X001                 | CNY17-3X001                 | CNY17-4X001                 |   |   |   |   |   |   |   |   |  |  |  |  |
| DIP-6, 400 mil, option 6   | CNY17-1X016                 | CNY17-2X016                 | CNY17-3X016                 | CNY17-4X016                 |   |   |   |   |   |   |   |   |  |  |  |  |
| SMD-6, option 7  | CNY17-1X017                 | CNY17-2X017T <sup>(1)</sup> | CNY17-3X017T <sup>(1)</sup> | CNY17-4X017T <sup>(1)</sup> |   |   |   |   |   |   |   |   |  |  |  |  |
| SMD-6, option 9  | -                           | CNY17-2X019T <sup>(1)</sup> | -                           | -                           |   |   |   |   |   |   |   |   |  |  |  |  |

### Note

<sup>(1)</sup> Also available in tubes, do not put T on the end.

| <b>ABSOLUTE MAXIMUM RATINGS</b> ( $T_{amb} = 25\text{ }^{\circ}\text{C}$ , unless otherwise specified) |                                      |            |             |                    |
|--|--------------------------------------|------------|-------------|--------------------|
| PARAMETER  | TEST CONDITION                       | SYMBOL     | VALUE       | UNIT               |
| <b>INPUT</b>   |                                      |            |             |                    |
| Reverse voltage  |                                      | $V_R$      | 6           | V                  |
| Forward current  |                                      | $I_F$      | 60          | mA                 |
| Forward surge current  | $t_p \leq 10\text{ }\mu\text{s}$     | $I_{FSM}$  | 2.5         | A                  |
| LED power dissipation  | at $25\text{ }^{\circ}\text{C}$      | $P_{diss}$ | 100         | mW                 |
| <b>OUTPUT</b>  |                                      |            |             |                    |
| Collector emitter breakdown voltage  |                                      | $BV_{CEO}$ | 70          | V                  |
| Emitter base breakdown voltage   |                                      | $BV_{EBO}$ | 7           | V                  |
| Collector current  |                                      | $I_C$      | 50          | mA                 |
|  | $t_p/T = 0.5, t_p \leq 10\text{ ms}$ | $I_C$      | 100         | mA                 |
| Power dissipation  |                                      | $P_{diss}$ | 150         | mW                 |
| <b>COUPLER</b>   |                                      |            |             |                    |
| Isolation test voltage between emitter and detector  | $t = 1\text{ min}$                   | $V_{ISO}$  | 5000        | $V_{RMS}$          |
| Storage temperature  |                                      | $T_{stg}$  | -55 to +150 | $^{\circ}\text{C}$ |
| Operating temperature  |                                      | $T_{amb}$  | -55 to +110 | $^{\circ}\text{C}$ |
| Soldering temperature <sup>(1)</sup>   | 2 mm from case, $\leq 10\text{ s}$   | $T_{sld}$  | 260         | $^{\circ}\text{C}$ |
| Total power dissipation  |                                      | $P_{diss}$ | 250         | mW                 |

**Notes**

- Stresses in excess of the absolute maximum ratings can cause permanent damage to the device. Functional operation of the device is not implied at these or any other conditions in excess of those given in the operational sections of this document. Exposure to absolute maximum ratings for extended periods of the time can adversely affect reliability.
- <sup>(1)</sup> Refer to reflow profile for soldering conditions for surface mounted devices (SMD). Refer to wave profile for soldering conditions for through hole devices (DIP).

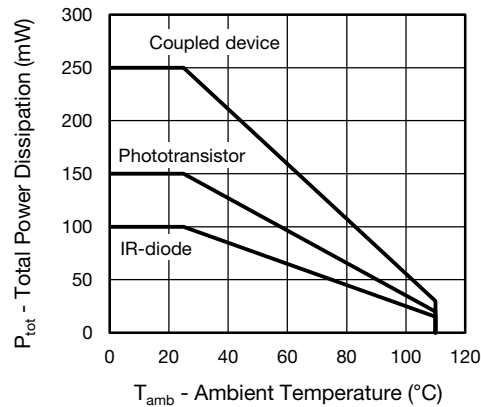

Fig. 1 - Total Power Dissipation vs. Ambient Temperature

| <b>ELECTRICAL CHARACTERISTICS</b> ( $T_{amb} = 25\text{ }^{\circ}\text{C}$ , unless otherwise specified) |                                      |      |          |      |      |      |               |
|--|--------------------------------------|------|----------|------|------|------|---------------|
| PARAMETER  | TEST CONDITION                       | PART | SYMBOL   | MIN. | TYP. | MAX. | UNIT          |
| <b>INPUT</b>   |                                      |      |          |      |      |      |               |
| Forward voltage  | $I_F = 60\text{ mA}$                 |      | $V_F$    |      | 1.39 | 1.65 | V             |
| Breakdown voltage  | $I_R = 10\text{ }\mu\text{A}$        |      | $V_{BR}$ | 6    |      |      | V             |
| Reverse current  | $V_R = 6\text{ V}$                   |      | $I_R$    |      | 0.01 | 10   | $\mu\text{A}$ |
| Capacitance  | $V_R = 0\text{ V}, f = 1\text{ MHz}$ |      | $C_O$    |      | 25   |      | pF            |
| Thermal resistance   |                                      |      | $R_{th}$ |      | 750  |      | K/W           |



| <b>ELECTRICAL CHARACTERISTICS</b> ( $T_{amb} = 25\text{ }^{\circ}\text{C}$ , unless otherwise specified) |  |         |             |      |      |      |      |
|--|--|---------|-------------|------|------|------|------|
| PARAMETER  | TEST CONDITION                               | PART    | SYMBOL      | MIN. | TYP. | MAX. | UNIT |
| <b>OUTPUT</b>  |  |         |             |      |      |      |      |
| Collector emitter capacitance  | $V_{CE} = 5\text{ V}$ , $f = 1\text{ MHz}$   |         | $C_{CE}$    |      | 5.2  |      | pF   |
| Collector base capacitance   | $V_{CE} = 5\text{ V}$ , $f = 1\text{ MHz}$   |         | $C_{CB}$    |      | 6.5  |      | pF   |
| Emitter base capacitance   | $V_{CE} = 5\text{ V}$ , $f = 1\text{ MHz}$   |         | $C_{EB}$    |      | 7.5  |      | pF   |
| Thermal resistance   |  |         | $R_{th}$    |      | 500  |      | K/W  |
| <b>COUPLER</b>   |  |         |             |      |      |      |      |
| Collector emitter, saturation voltage  | $V_F = 10\text{ mA}$ , $I_C = 2.5\text{ mA}$ |         | $V_{CEsat}$ |      | 0.25 | 0.4  | V    |
| Coupling capacitance   |  |         | $C_C$       |      | 0.6  |      | pF   |
| Collector emitter, leakage current   | $V_{CE} = 10\text{ V}$                       | CNY17-1 | $I_{CEO}$   |      | 2    | 50   | nA   |
|  |  | CNY17-2 | $I_{CEO}$   |      | 2    | 50   | nA   |
|  |  | CNY17-3 | $I_{CEO}$   |      | 5    | 100  | nA   |
|  |  | CNY17-4 | $I_{CEO}$   |      | 5    | 100  | nA   |

**Note**

- Minimum and maximum values were tested requirements. Typical values are characteristics of the device and are the result of engineering evaluations. Typical values are for information only and are not part of the testing requirements.

| <b>CURRENT TRANSFER RATIO</b> ( $T_{amb} = 25\text{ }^{\circ}\text{C}$ , unless otherwise specified) |  |         |        |      |      |      |      |
|--|--|---------|--------|------|------|------|------|
| PARAMETER  | TEST CONDITION                               | PART    | SYMBOL | MIN. | TYP. | MAX. | UNIT |
| $I_C/I_F$  | $V_{CE} = 5\text{ V}$ , $I_F = 10\text{ mA}$ | CNY17-1 | CTR    | 40   |      | 80   | %    |
|  |  | CNY17-2 | CTR    | 63   |      | 125  | %    |
|  |  | CNY17-3 | CTR    | 100  |      | 200  | %    |
|  |  | CNY17-4 | CTR    | 160  |      | 320  | %    |
|  | $V_{CE} = 5\text{ V}$ , $I_F = 1\text{ mA}$  | CNY17-1 | CTR    | 13   | 30   |      | %    |
|  |  | CNY17-2 | CTR    | 22   | 45   |      | %    |
|  |  | CNY17-3 | CTR    | 34   | 70   |      | %    |
|  |  | CNY17-4 | CTR    | 56   | 90   |      | %    |

| <b>SWITCHING CHARACTERISTICS</b> ( $T_{amb} = 25\text{ }^{\circ}\text{C}$ , unless otherwise specified) |   |         |           |      |      |      |               |
|---|---|---------|-----------|------|------|------|---------------|
| PARAMETER   | TEST CONDITION  | PART    | SYMBOL    | MIN. | TYP. | MAX. | UNIT          |
| <b>LINEAR OPERATION</b> (without saturation)  |   |         |           |      |      |      |               |
| Turn-on time  | $I_F = 10\text{ mA}$ , $V_{CC} = 5\text{ V}$ , $R_L = 75\text{ }\Omega$ |         | $t_{on}$  |      | 3    |      | $\mu\text{s}$ |
| Rise time   | $I_F = 10\text{ mA}$ , $V_{CC} = 5\text{ V}$ , $R_L = 75\text{ }\Omega$ |         | $t_r$     |      | 2    |      | $\mu\text{s}$ |
| Turn-off time   | $I_F = 10\text{ mA}$ , $V_{CC} = 5\text{ V}$ , $R_L = 75\text{ }\Omega$ |         | $t_{off}$ |      | 2.3  |      | $\mu\text{s}$ |
| Fall time   | $I_F = 10\text{ mA}$ , $V_{CC} = 5\text{ V}$ , $R_L = 75\text{ }\Omega$ |         | $t_f$     |      | 2    |      | $\mu\text{s}$ |
| Cut-off frequency   | $I_F = 10\text{ mA}$ , $V_{CC} = 5\text{ V}$ , $R_L = 75\text{ }\Omega$ |         | $f_{CO}$  |      | 110  |      | kHz           |
| <b>SWITCHING OPERATION</b> (with saturation)  |   |         |           |      |      |      |               |
| Turn-on time  | $I_F = 20\text{ mA}$  | CNY17-1 | $t_{on}$  |      | 3    |      | $\mu\text{s}$ |
|   |   | CNY17-2 | $t_{on}$  |      | 4.2  |      | $\mu\text{s}$ |
|   | $I_F = 10\text{ mA}$  | CNY17-3 | $t_{on}$  |      | 4.2  |      | $\mu\text{s}$ |
|   |   | CNY17-4 | $t_{on}$  |      | 6    |      | $\mu\text{s}$ |
| Rise time   | $I_F = 20\text{ mA}$  | CNY17-1 | $t_r$     |      | 2    |      | $\mu\text{s}$ |
|   |   | CNY17-2 | $t_r$     |      | 3    |      | $\mu\text{s}$ |
|   | $I_F = 10\text{ mA}$  | CNY17-3 | $t_r$     |      | 3    |      | $\mu\text{s}$ |
|   |   | CNY17-4 | $t_r$     |      | 4.6  |      | $\mu\text{s}$ |
| Turn-off time   | $I_F = 20\text{ mA}$  | CNY17-1 | $t_{off}$ |      | 18   |      | $\mu\text{s}$ |
|   |   | CNY17-2 | $t_{off}$ |      | 23   |      | $\mu\text{s}$ |
|   | $I_F = 10\text{ mA}$  | CNY17-3 | $t_{off}$ |      | 23   |      | $\mu\text{s}$ |
|   |   | CNY17-4 | $t_{off}$ |      | 25   |      | $\mu\text{s}$ |
| Fall time   | $I_F = 20\text{ mA}$  | CNY17-1 | $t_f$     |      | 11   |      | $\mu\text{s}$ |
|   |   | CNY17-2 | $t_f$     |      | 14   |      | $\mu\text{s}$ |
|   | $I_F = 10\text{ mA}$  | CNY17-3 | $t_f$     |      | 14   |      | $\mu\text{s}$ |
|   |   | CNY17-4 | $t_f$     |      | 15   |      | $\mu\text{s}$ |

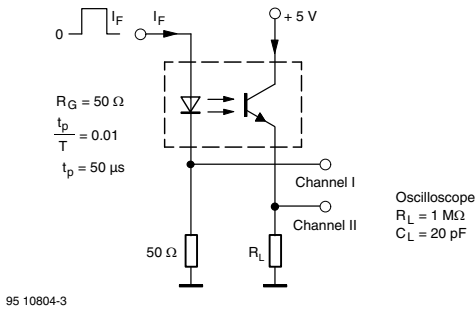

Fig. 2 - Test Circuit, Non-Saturated Operation

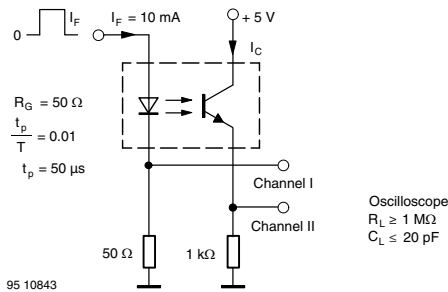

Fig. 3 - Test Circuit, Saturated Operation

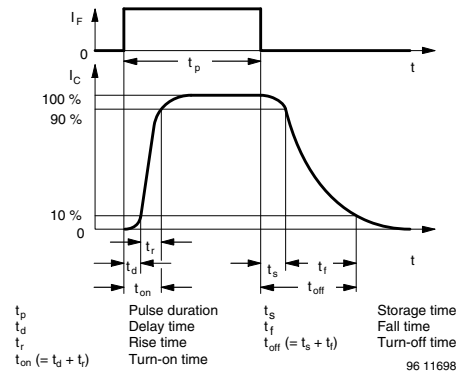

Fig. 4 - Switching Times

| SAFETY AND INSULATION RATINGS                                |  |                   |                    |                   |
|--|--|-------------------|--------------------|-------------------|
| PARAMETER  |  | SYMBOL            | VALUE              | UNIT              |
| <b>MAXIMUM SAFETY RATINGS</b>                                |  |                   |                    |                   |
| Output safety power  |  | P <sub>SO</sub>   | 700                | mW                |
| Input safety current   |  | I <sub>SI</sub>   | 400                | mA                |
| Safety temperature   |  | T <sub>SI</sub>   | 175                | °C                |
| Comparative tracking index                                   |  | CTI               | 175                |                   |
| <b>INSULATION RATED PARAMETERS</b>                           |  |                   |                    |                   |
| Maximum withstanding isolation voltage                       |  | V <sub>ISO</sub>  | 5000               | V <sub>RMS</sub>  |
| Maximum transient isolation voltage                          |  | V <sub>IOTM</sub> | 8000               | V <sub>peak</sub> |
| Maximum repetitive peak isolation voltage                    |  | V <sub>IORM</sub> | 890                | V <sub>peak</sub> |
| Insulation resistance  | T <sub>amb</sub> = 25 °C, V <sub>DC</sub> = 500 V  | R <sub>IO</sub>   | ≥ 10 <sup>12</sup> | Ω                 |
| Isolation resistance   | T <sub>amb</sub> = 100 °C, V <sub>DC</sub> = 500 V | R <sub>IO</sub>   | ≥ 10 <sup>11</sup> | Ω                 |
| Climatic classification (according to IEC 68 part 1)         |  |                   | 55/115/21          |                   |
| Environment (pollution degree in accordance to DIN VDE 0109) |  |                   | 2                  |                   |
| Creepage distance  | Standard DIP-4                                     |                   | ≥ 7                | mm                |
|  | SMD  |                   | ≥ 7                | mm                |
| Clearance distance   | Standard DIP-4                                     |                   | ≥ 8                | mm                |
|  | SMD  |                   | ≥ 8                | mm                |
| Insulation thickness   |  | DTI               | ≥ 0.4              | mm                |

**Note**

- As per DIN EN 60747-5-5, § 7.4.3.8.2, this optocoupler is suitable for “safe electrical insulation” only within the safety ratings. Compliance with the safety ratings shall be ensured by means of protective circuits.

**TYPICAL CHARACTERISTICS** ( $T_{amb} = 25\text{ }^{\circ}\text{C}$ , unless otherwise specified)



Fig. 5 - Forward Voltage vs. Forward Current



Fig. 8 - Leakage Current vs. Ambient Temperature



Fig. 6 - Collector Current vs. Collector Emitter Voltage (NS)



Fig. 9 - Normalized CTR (NS) vs. Ambient Temperature



Fig. 7 - Collector Current vs. Collector Emitter Voltage (sat)



Fig. 10 - Normalized CTR (sat) vs. Ambient Temperature



Fig. 11 - Normalized CTR (NS) vs. Forward Current



Fig. 14 - CTR -3 dB Frequency vs. Collector Current



Fig. 12 - Normalized CTR (sat) vs. Forward Current

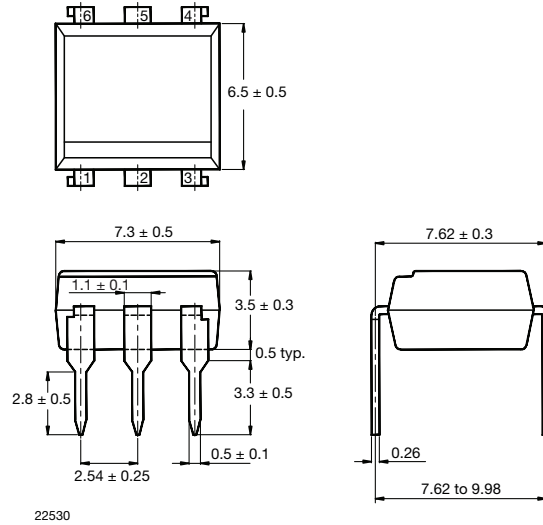

Fig. 15 - Switching Time vs. Load Resistance

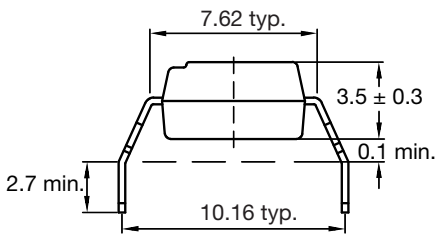

Fig. 13 - CTR Frequency vs. Phase Angle

**PACKAGE DIMENSIONS** in millimeters



**Option 6**



**Option 7**

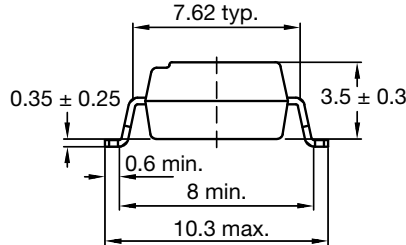

**Option 9**

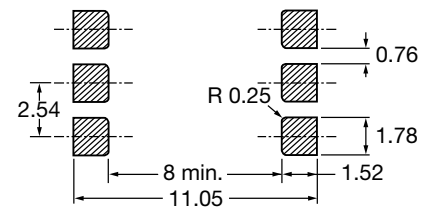
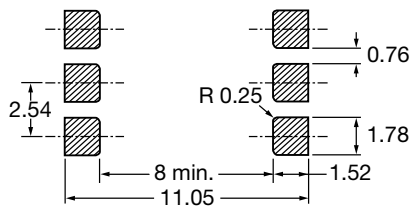
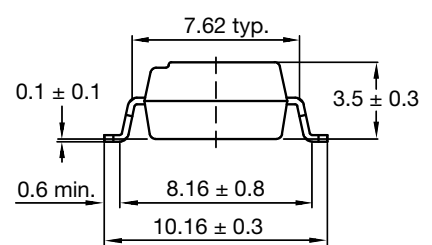

20802-34

**PACKAGE MARKING**

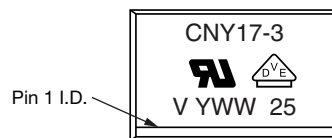

**Notes**

- VDE logo is only marked on option 1 parts. Option information is not marked on the part.
- Tape and reel suffix (T) is not part of the package marking.



TUBE AND TAPE INFORMATION

| DEVICES PER TUBE |            |           |           |
|------------------|------------|-----------|-----------|
| TYPE             | UNITS/TUBE | TUBES/BOX | UNITS/BOX |
| DIP-6            | 50         | 40        | 2000      |

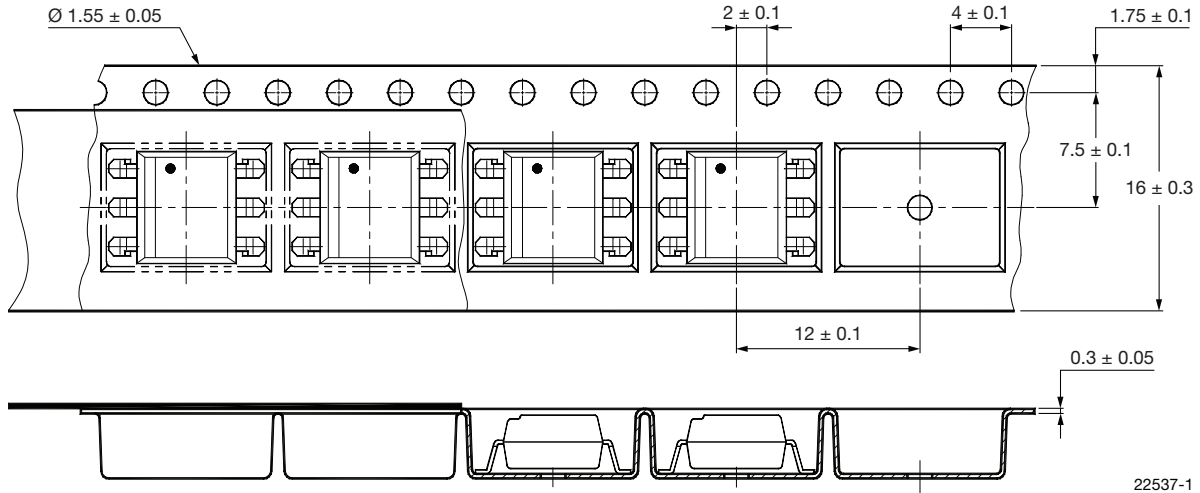

Fig. 16 - Tape and Reel Drawing, 1000 Units per Reel





## Disclaimer

ALL PRODUCT, PRODUCT SPECIFICATIONS AND DATA ARE SUBJECT TO CHANGE WITHOUT NOTICE TO IMPROVE RELIABILITY, FUNCTION OR DESIGN OR OTHERWISE.

Vishay Intertechnology, Inc., its affiliates, agents, and employees, and all persons acting on its or their behalf (collectively, "Vishay"), disclaim any and all liability for any errors, inaccuracies or incompleteness contained in any datasheet or in any other disclosure relating to any product.

Vishay makes no warranty, representation or guarantee regarding the suitability of the products for any particular purpose or the continuing production of any product. To the maximum extent permitted by applicable law, Vishay disclaims (i) any and all liability arising out of the application or use of any product, (ii) any and all liability, including without limitation special, consequential or incidental damages, and (iii) any and all implied warranties, including warranties of fitness for particular purpose, non-infringement and merchantability.

Statements regarding the suitability of products for certain types of applications are based on Vishay's knowledge of typical requirements that are often placed on Vishay products in generic applications. Such statements are not binding statements about the suitability of products for a particular application. It is the customer's responsibility to validate that a particular product with the properties described in the product specification is suitable for use in a particular application. Parameters provided in datasheets and/or specifications may vary in different applications and performance may vary over time. All operating parameters, including typical parameters, must be validated for each customer application by the customer's technical experts. Product specifications do not expand or otherwise modify Vishay's terms and conditions of purchase, including but not limited to the warranty expressed therein.

Except as expressly indicated in writing, Vishay products are not designed for use in medical, life-saving, or life-sustaining applications or for any other application in which the failure of the Vishay product could result in personal injury or death. Customers using or selling Vishay products not expressly indicated for use in such applications do so at their own risk. Please contact authorized Vishay personnel to obtain written terms and conditions regarding products designed for such applications.

No license, express or implied, by estoppel or otherwise, to any intellectual property rights is granted by this document or by any conduct of Vishay. Product names and markings noted herein may be trademarks of their respective owners.

## Material Category Policy

**Vishay Intertechnology, Inc. hereby certifies that all its products that are identified as RoHS-Compliant fulfill the definitions and restrictions defined under Directive 2011/65/EU of The European Parliament and of the Council of June 8, 2011 on the restriction of the use of certain hazardous substances in electrical and electronic equipment (EEE) - recast, unless otherwise specified as non-compliant.**

**Please note that some Vishay documentation may still make reference to RoHS Directive 2002/95/EC. We confirm that all the products identified as being compliant to Directive 2002/95/EC conform to Directive 2011/65/EU.**

**Vishay Intertechnology, Inc. hereby certifies that all its products that are identified as Halogen-Free follow Halogen-Free requirements as per JEDEC JS709A standards. Please note that some Vishay documentation may still make reference to the IEC 61249-2-21 definition. We confirm that all the products identified as being compliant to IEC 61249-2-21 conform to JEDEC JS709A standards.**